



Templeton House

Award Winning Timber Windows and Doors of Exceptional Quality

FULL PRODUCT BROCHURE





Introduction to Gowercroft

We are a premium quality, full service, UK manufacturer of joinery products with extended guarantees, designing, manufacturing and installing award winning windows and doors of exceptional quality for new build, renovation and heritage projects.



Introduction

Why buy our products?	7
Why use our dealership network?	8
Our ranges - overview of options	10

Classic Range

22

Case studies	24
Chatsworth	32
Hardwick	34
Wollaton	36
Kedleston	38
Melbourne	40
Tutbury	42
Peveil	44

Heritage Range

46

Case studies	48
Winston	56
Richmond	58
Belton	60
Clement	62
Churchill	64
Halifax	66

Frontier Range

68

Tatra	70
Acadia	72
Kruger	74
Denali	76
Brecon	78
Lomond	80

Complimentary Products

82

Roof lanterns	84
Hygge contemporary doors	86
Trims	88

About Gowercroft

90

UK manufacturer	92
Sustainability	94
Meet the key people	96

Introduction

Timber windows and doors dominated the UK-market for thousands of years, but the market share plummeted in the 1980s and 1990s due to quality issues and new entrants. It was common for people to complain of high maintenance and short lifespans. However, the timber window market has been through a rebirth focusing heavily on quality, longevity and performance; it is quickly growing and timber is now the material of choice for any discerning customer. Below are some of the main reasons for choosing timber over other material options:

Sustainability

Timber is the only truly sustainable building material. It doesn't matter how much money other sectors spend on marketing and recycling, they will never be able to match timber for sustainability. When timber is sourced from renewable forests it creates a significant Carbon sink while securing local employment and critical habitat. To learn more about the benchmarked sustainability of Gowercroft timber products, see pages 94-95 of this brochure.

Longevity

A report produced by Heriot Watt University compared the service life of windows using timber, modified timber, Aluminium-clad timber and PVCu frames. The report showed an expected service life for a timber window frame of between 56 and 65 years, extending to 68-80 years for an Accoya™ window frame. This is compared to PVC-u expected lifespan between 25 and 35 years.

Whole Life Costs

The same report by Heriot Watt University goes on to compare ownership cost of windows using timber, modified timber, Aluminium-clad timber and PVCu frames. It compares the cost of initial purchase, ongoing maintenance and any replacement requirement over a 60, 80 and 100 year period. Timber products were less expensive over each of the periods than uPVC products.



Low Maintenance And Repair

Modern, high quality timber windows offer extremely low maintenance. They often need nothing more than a regular clean and then period recoating every 7-10 years. With modern water-based coatings, this process is straightforward and doesn't require much preparation. It's worth noting that all windows start to show considerable wear and tear before the end of their service life and repairs are often not possible on uPVC or Aluminium products. Timber products can be refinished to suit modern taste, reglazed to ensure that they meet current performance standards, and repaired if any damage occurs through the years.

Materials Health

There is a mounting body of evidence which demonstrates the health and well-being benefits to occupants of having natural materials within the property. Natural materials reach equilibrium with their environment and can balance moisture and temperature levels to give higher levels of comfort. Timber windows and doors can form an important part of biophilic design. Independent studies by Greenpeace and others have demonstrated the risks associated with off-gassing from synthetic materials in the home and to the environment as a whole in the production and disposal of PVC material.

How They Look And Feel

Nothing can beat the elegance, natural individuality, and warmth of wood. The proportions, traditional profiles and the depth of the products match the architecture and history of our building stock and cannot be accurately replicated by other materials. By using timber windows, you are maintaining traditional features and protecting the long-term aesthetic of your property. Ultimately, there is no reason to settle for a lower-quality imitation if you can afford the real deal.

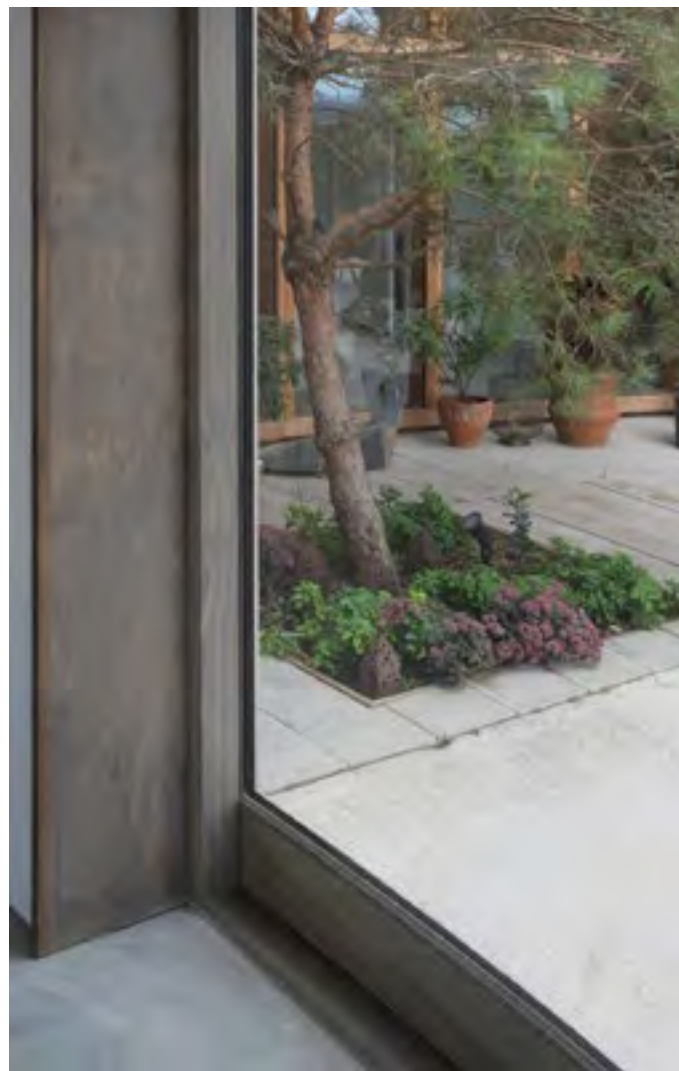

Protecting Your Investment

For the vast majority of people, the largest asset they will own is their home, so protecting its value is very important. It's well known that properties with traditional features and character sell more quickly and for more money than those without. The look and feel of a house is very important in a buyer's decision making process. By installing traditional timber windows and doors, you are maintaining or creating that character, and as a result they are much more of an investment.

"I looked at several options for windows. I chose Gowercroft Timber windows, and I am so happy I did. The products are highly effective, and all of our neighbours have visited to get details of the supplier."

Rachel Gilbert



Award Winning Windows and Doors

When you buy Gowercroft windows and doors you have the assurance of knowing that the industry recognises our products as some of the best available. Our windows and doors have won and been short-listed for numerous national, industry awards, including winning Best Windows at the 2017 Build It Awards. We have also won recognition for both our project delivery and our business as a whole.

Industry leading performance

We have undertaken major product development, utilising the skills and experience of Universities, suppliers and customers, to create products which really work. Our products are always designed to deliver exceptional guarantees, excellent performance in security and weather testing, and traditional British aesthetics together with setting new standards on sustainability and materials health.

No quibble 10-year guarantee

We take a completely unique perspective on guarantees! We believe that a warranty is a relationship and by respecting that relationship, we save a lot of money on marketing. We are so confident that our windows and doors will perform in the long term, we offer a 10-year no maintenance guarantee with all our painted products. No small print about unachievable maintenance schedules, no exclusions and no “materials only” clauses.

Why Buy Our Products?

25 years uninterrupted trading

Our guarantees are supported by our trading history dating back to 1998. Although we have grown during that time from a small bespoke joinery shop to a nationally known supplier of high-quality windows and doors, our approach and ownership haven't changed. We always seek steady and sustainable growth which puts the customer first. Our guarantees have genuine value because we will be here to honour them.

Unique Supplier Relationships

Whether this is arrangements to increase the competitiveness of our products, offer unique and innovative materials, provide industry-beating, supplier-backed warranties, or ensure availability of raw materials - we always work proactively with our suppliers to build resilient supply chains and exceptional products.

British manufacturer, locally owned

We continue to invest in our Derbyshire manufacturing facility to meet the ever-increasing demand for our products. We carry out every part of the process from Derbyshire with either direct-employed staff or carefully chosen and trusted partner organisations. We are only ever a short drive away if you need us and our door is (almost) always open!



Look how we have grown!

The Gowercroft workshop as it is today and (inset) our very first workshop in Wirksworth.





We offer the best product guarantee available, speak to us for full details

Need More Assurance?

Our guarantee is already the best in the industry; TimbaCare extends that indefinitely. It maximises the value of your home and is fully transferable if you ever choose to move on.

TimbaCare includes a yearly visit, where the service engineer will talk to you about any concerns they have from the previous year and then run through a 10-point checklist for every product.

Any required maintenance is then carried out to the products on the same day. Depending on the number of years since install, the engineer may also clean the products and apply a full external coat of revitaliser or paint.

The cost of the programme will depend upon a range of factors including the size of the project, the coating type and maintenance cycle, and the location in the country. The yearly charge is fixed for the first 25 years and will usually represent between 2% and 4% of the product cost.



TimbaCare allows customers who have purchased Gowercroft windows and doors to pay a small, flat-fee each year to have all maintenance taken care of. This gives you peace of mind and ensures the products always look their best.

For further information on our guarantees or TimbaCare, speak to your local supplier.

Why Use Our Dealership Network?

The finest windows and doors, delivered by your local partner.

Although as a business, Gowercroft cover the whole of the UK, in certain areas we work with local companies so we can deliver our industry leading products, but with a more localised service and support. We select our partners very carefully based on service levels and a real understanding of the product; they offer an exceptional service across the country on our behalf.

If you are interested in getting a no obligation estimate or finding our more information, then please contact our head office so we can refer you to the correct partner:

Phone: 01773 300510

Email: info@gowercroft.com



The Ranges

We offer three ranges, designed to fulfil all our customers' needs. This page will help you narrow down the correct option for your property.

Classic Range - Wooden Windows and Doors for every situation



Our Classic range of modern, double and triple glazed doors and windows have a timeless appeal that suits most styles of new build properties as well as replacement windows for refurbishment projects. Manufactured to the latest building regulations, they are an excellent value for money solution for homes that do not have specialist building conservation or passivhaus requirements.

Heritage Range - Perfect for Conservation areas and Listed Properties



Our award-winning Heritage range of windows and doors was developed specifically for old and Listed properties in conservation areas. Designed with ultra-slim vacuum 8.3mm thick glazing, thin sections, and traditional ironmongery, they have the traditional appearance of a single glazed window combined with outstanding energy efficiency and performance features.

Frontier Range - Extreme Performance Timber Windows and Doors



Designed for the future-build market, the Frontier range is our most technically advanced range of windows and doors. Constructed from FSC-Certified Accoya®, with a proprietary vacuum cavity unit and a specially adapted Italian paint system – the Frontier range pushes the boundaries of window technology whilst retaining an elegant slim appearance.



Which product is right for me...?

Not sure which product is right for you? Use this at-a-glance guide to see the difference in our comparable products.

	Classic Range	Heritage Range	Frontier Range
Use	Perfect for renovation works and new builds	Perfect for Conservation areas and Listed Properties	Perfect for Future Builds with higher performance, sustainability or materials health requirements
Energy Efficiency	1.4 for standard size window	1.2 for standard size window	0.9 for standard size window
Air Permeability EN14350-1	Class 4	Untested	Class 4
Air Loss EN12209	Class 4	Untested	Class 4
Security	Part Q Tested and Compliant	Untested	Part Q Tested and Compliant
Warranty	10-year no maintenance warranty	10-year no maintenance warranty	10-year no maintenance warranty
Lifespan	Estimated 60-70 year lifespan	Estimated 70-80 year lifespan	Estimated 70-80 year lifespan
Lead-time	Estimated 8 week lead-time	Estimated 14 week lead-time	Estimated 14 week lead-time
Cost	££	£££	£££
Trickle Ventilation	Concealed except on Open In Products	Typically avoidable due to Heritage Dispensation	Concealed except on Open In Products

The difference is in the details

All products are designed to combine traditional aesthetics with unparalleled performance

- Thinner than industry-standard sections to deliver more sunlight, better vistas and improved energy efficiency.
- Perfectly flush jointing with no unsightly grooves or breaks.
- 18 - 22mm external glazing bars and 9mm external bevel to replicate the traditional linseed oil putty effect. Internal 18 - 22mm glazing bars and 18mm beads in a traditional profile to give elegance and slenderness of sections.
- Full paint system delivering exceptional life span and minimal maintenance schedules.

Comb joint construction increases product longevity and stability.

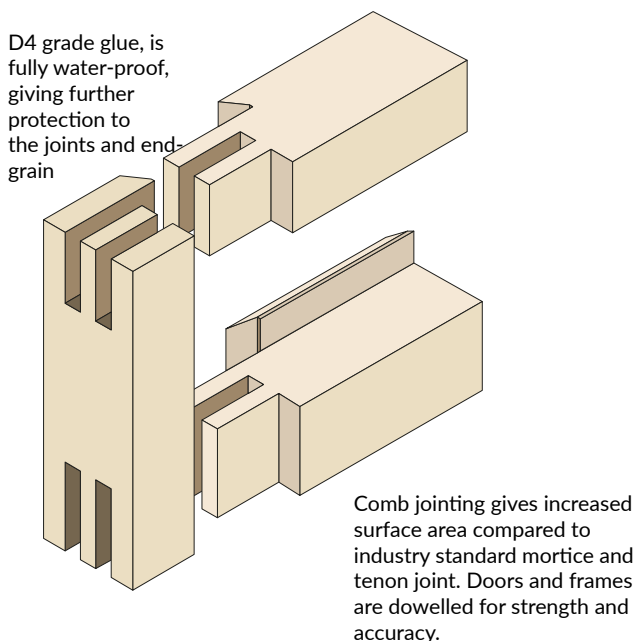

Internally glazed product with concealed pinning to give maximum security and best possible finish.

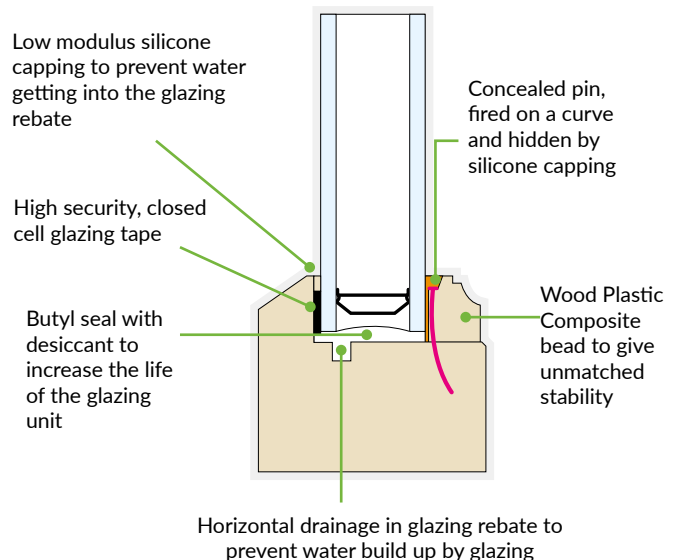

Double gasketing and patented seal arrangements on Classic and Frontier ranges deliver the best air permeability ratings in the industry. Heritage range has mix of concealed gaskets for traditional aesthetic.

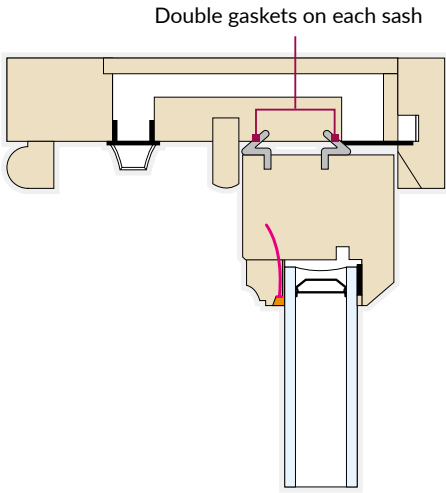

Sliding Sash

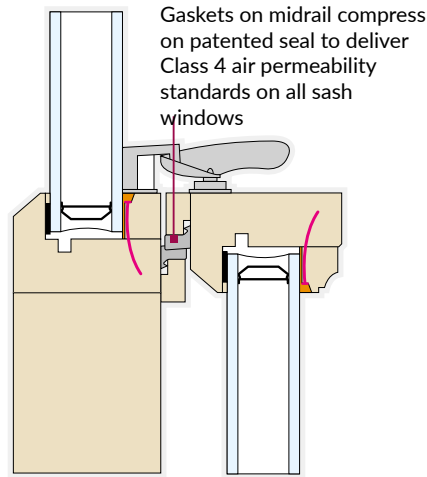

Sliding Sash

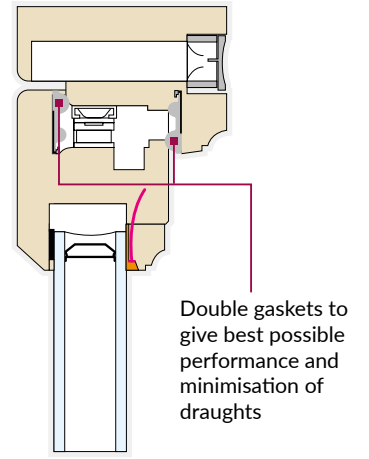

Flush Casement and Doors

Trickle ventilation designed to detract as little as possible from the aesthetics of the product, running through the head of the frame and invisible on the external face.

High technology, applied glazing beads with deep bonded bars in glazing units to give longevity and traditional appearance.

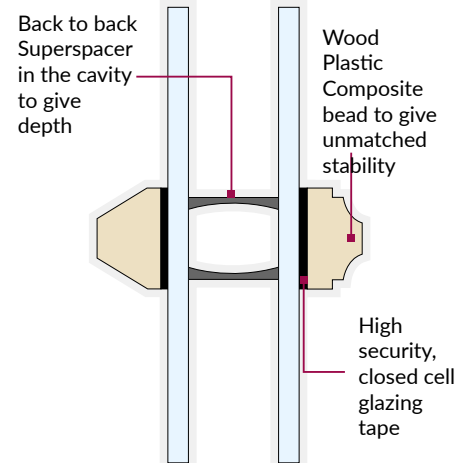
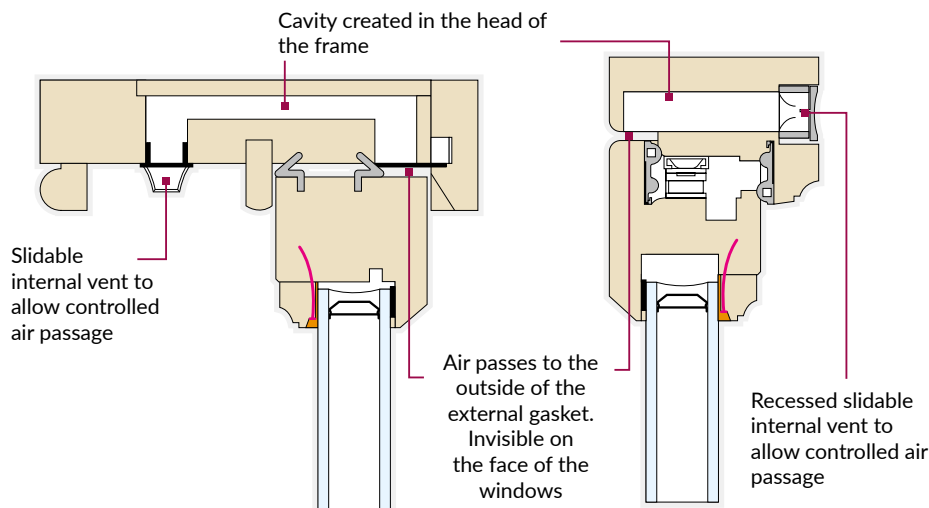

Timber Options

We have selected only **100% F.S.C. timbers** for our standard options. We do, however, have comfort working in a great variety of sustainably-sourced hardwoods if required.

INTERESTING FACT: The tallest ever recorded was known as “The Grandis” near Bulahdelah in New South Wales, with a height of 86 m (282 ft) and a girth of 8.5 m (28 ft).

Engineered Red Grandis

A high-grade clear timber delivering consistency of appearance, grain and workability. We purchase this timber mainly as an Engineered Component offering proven strength and efficiency.

Red Grandis has undergone independent third-party testing by TRADA Technology Limited and Building Research Establishment, achieving great results for natural durability and resistance to fungi – (key for long term performance), as well as Class D35 for strength and stiffness and Class C35 for density to prove its suitability for joinery and structural use.

Under the plantation growing process intensive pruning is carried out to provide a knot free, clear, uniform timber with sapling thinning to enable the trees to reach significant diameters. It is easy to machine and shape and because all lengths are identical, there is less waste and reduced production time, as well as giving a much better finish overall – great for us and for our customers.

Formal name:
Eucalyptus grandis.

Growth to full maturity:
25 years, saplings have been known to put on 7m of growth in the first year!

Location of growth:
Native to East coast of Australia, now grown in plantations in Australia, New Zealand, South Africa, Sri Lanka, Brazil and Uruguay.

Estimated lifespan in external joinery application:
50 years+. Please note that this figure would be based on sensible coating cycles and good maintenance.

Quality of paint finish:
Very good, grain clearly visible



Accoya is the world's leading high technology wood. Created from sustainably sourced softwood; it matches or exceeds the durability and stability of the very best tropical hardwoods.

Accoya wood production takes sustainably-sourced, fast growing softwood and, in a non-toxic process, creates a durable and stable wood.

The technology behind Accoya is based on acetylation, a process that has been studied by scientists around the world for more than 75 years. Acetylation effectively changes the free hydroxyls within the wood into acetyl groups. When this happens the ability of the wood to absorb water is greatly reduced, rendering the wood more dimensionally stable and, because it is no longer digestible, extremely durable.

Typically, we use this material in external applications, including windows (of all kinds), doors and conservatories. There are some applications where Accoya is particularly well suited, including long runs of sliding, folding doors, projects where final quality is absolutely critical and highly exposed external applications. Gowercroft were among the first to embrace this timber in the early 2000's and are fully certified users under the Accsys Technology scheme.

Formal name:

Pinus radiata or Radiata Pine. Chemical modification process transforms this timber into Accoya.

Growth to full maturity:

20-25 years

Location of growth:

Native to California and Mexico, now grown in extensive plantations in New Zealand, as well as Australia, Spain, Argentina, Chile, Uruguay, Kenya, and South Africa.

Estimated lifespan in external joinery application:

60 years+. Please note that this figure would be based on sensible coating cycles and good maintenance.

Quality of paint finish:

Exceptionally good, little grain visible

INTERESTING FACT:

The cones of this tree are serotinous, i.e. they remain closed until opened by the heat of a forest fire; the abundant seeds are then discharged to regenerate on the burned forest floor. The cones may also burst open in hot weather!



Glass Specification

All of our glass comes with a full 10-year guarantee against unit breakdown.

All products are internally glazed as standard, with full integrated drainage, high security closed-pore glazing tape to both faces and silicone seal internally and externally.



Means this glass complies with Part Q of building regulations required for accessible items in new build properties.

Comfort Pack

The standard option represents what has become the modern standard for energy efficient double glazed windows.

Energy performance: centre pane **U-value is 1.1**
Acoustic performance: **RW31dB**

Outer Pane	Clear	4mm
Cavity	Argon-filled	20mm
Inner Pane	Low E, Total+	4mm



Security Pack

With enhanced security and basic acoustic improvement, the Security option builds on the energy efficiency properties of the Comfort option for double glazed windows.

Energy performance: centre pane **U-value is 1.1**
Acoustic performance: **RW35dB**

Outer Pane	Clear	6.8mm
Cavity	Argon-filled	16mm
Inner Pane	Low E, Total+	4mm



Energy Pack

The Energy option provides a highly energy efficient solution for triple glazed windows. Triple glazed units allow a high level of solar heat gain, capturing free heat energy from natural daylight to warm the home.

Energy performance: centre pane **U-value is 0.7**
Acoustic performance: **RW35dB**

Outer Pane	Clear	4mm
Cavity	Argon-filled	16mm
Pane 2	Low E, Total+	4mm
Cavity	Argon-filled	12mm
Inner Pane	Low E, Total+	4mm



Silence Pack

The Silence option represents a glazing specification that delivers real peace and quiet for those customers who want to escape from the hustle and bustle of the outside world.

Energy performance: centre pane **U-value is 1.2**
Acoustic performance: **RW37dB**

Outer Pane	Eco PVB interlayer	6.4mm
Cavity	Argon-filled	12mm
Inner Pane	Stadip Silence	8.8mm



Ultimate Pack

The Ultimate option offers homeowners the optimum performance characteristics available for triple glazed window units.

Energy performance: centre pane **U-value is 0.7**

Acoustic performance: **RW38dB**

Outer Pane	Diamant	6mm
Cavity	Argon-filled	12mm
Pane 2	Low E, Total+	4mm
Cavity	Argon-filled	12mm
Inner Pane	Eco PVB Interlayer	6.8mm



Heritage Vacuum Glazing

The future of fenestration! Vacuum glazing offers exceptional energy performance and acoustic value. This ultra thin profile means using either the heritage or frontier window and door range.

Energy performance: centre pane **U-value is 0.4**

Acoustic performance: **RW36dB**

Outer Pane	Clear Tough	4mm
Cavity	Vacuum-filled	0.3mm
Inner Pane	Low E Tough	4mm



Optimum Vacuum Glazing

As the LandVac Vacuum Glazing, but with the added benefit of a laminated outer pane for compliance with P1A security standards. Also, the warm edge spacer greatly improves Psi value of the unit.

Energy performance: centre pane **U-value is 0.4**

Acoustic performance: **RW39dB**

Outer Pane	Eco PVB Interlayer	6.8mm
Cavity	Argon-filled	10mm
Pane 2	Clear Tough	4mm
Cavity	Vacuum-filled	0.3mm
Inner Pane	Low E Tough	4mm



U-Values: A U-value is the rate of heat loss through a material. The lower the U-Value, the less heat will be lost and the more efficient (and money saving) the unit will be. Please note that highly efficient glazing units are likely to experience external condensation in certain climatic conditions. If you would like more information, please ask your sales representative.

Acoustic Performance: Acoustic performance levels are expressed using the index R_w (C; Ctr) expressed in decibels (dB). R_w is used to categorise products and compare them to one another. A higher number represents a higher percentage reduction of the noise frequency.

The R_w value is not normally used to assess the sound insulation level of a particular element. For noise containing predominantly high- and medium-range frequencies, the sound insulation level of a product is determined using the index $R_w + C = RA$.

Please note that the order of panes within these glass packs may be changed to incorporate other features of your project better; i.e. obscure glazing. This is at our discretion but will not significantly alter the overall performance characteristics given.

A Guide to Vacuum Glazing

The future of glass units, offering extreme performance in an ultra thin and highly sustainable unit. Note that this glass has small pillars within the unit which are visible when close up and plugs/getters which can be visible in very large glass units. There is also a chance that low levels of distortion are visible on the surface of the glass units.

Modern Ironmongery

We offer a full suite of modern ironmongery as standard with our products. These are selected to offer the best possible functionality and compatibility, and have a full 10 year warranty on functionality and finish.

Below is a small selection of the options available, please speak to your sales representative for a full range.

Graphite
Architectural Door
Handles



Graphite Tear Drop
Casement Handle



Antique Black
Monkey Tail
Casement Handle



Lockable Fitch
Catch for Sliding
Sash

Fab&Fix hardware is elegantly designed to make a dynamic impact on your home's overall appearance whilst delivering state of the art functionality. With 5 unique styles and a diverse range of hardware to choose from, your home can be as unique as you want it to be. The palette currently includes 13 colours, all of which are well-considered, aesthetically perfect in finish and give a high-quality hardware appearance to any door or window.

ERA

We also offer a full suite of traditional ironmongery that's made in Britain. These are selected to offer the best possible functionality and compatibility in heritage applications. These have a full 10 year warranty on functionality, but will intentionally tarnish over time and through use.

Below is a small selection of the options available, please speak to your sales representative for a full range.

Antique Black Tear
Drop Casement Stay



Aged Brass Reeded
Casement Handle



Aged Brass Art Deco
Door Knob



Black Hook Fastener
for Sliding Sash

From The Anvil are specialist manufacturers of traditional and period ironmongery with over twenty years of experience. Their expert Blacksmiths hand craft exquisite products by forging mild steel and hot forging brass to make one-of-a-kind ironmongery that will last a lifetime. They have a wide range of compatible handles for Gowercroft windows and doors, which can be finished in traditional finishes including antique black, aged brass, aged bronze, antique pewter, and polished nickel to name a few.

Please visit fromtheanvil.co.uk for inspiration and ideas.

Paint Finishes

All of our products are delivered to site fully finished with three coats of high quality, water-based coating and should require no further decoration after installation. We have a standard range for convenience, but we can supply any colours in any combination of split internal and external finishes.

Popular Paint Colours

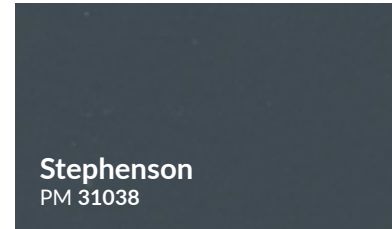
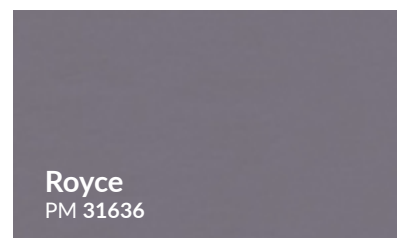
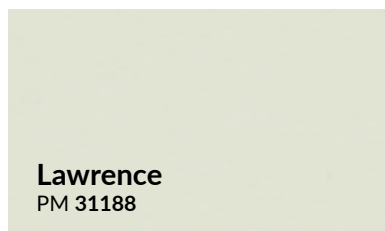
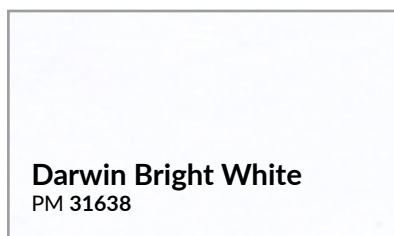
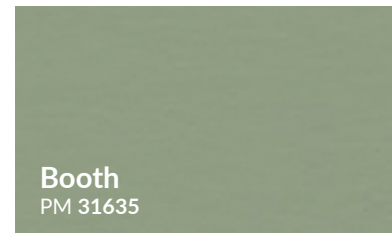
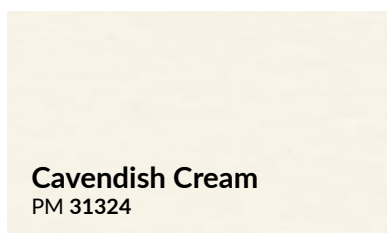

Popular Stain Colours



Please note: these stains are shown on Red Grandis, please ask for physical samples on Accoya. Also note that wood is a natural material and colouration will vary across pieces, this is part of the character of the product.

Our coating system is the best in the industry and offers incredibly low maintenance requirements. Any painted product utilising the full three coat system will include a full 10-year, no maintenance guarantee backed by our supplier.

We also offer a full aftercare service, which allows you to protect your investment by having our skilled joiners and decorators complete all required maintenance for you. Details of this service can be found on page 7 of this booklet or on our website or by talking to your sales representative.

Maintenance free, water based microporous paint coatings



The Advantages

- Does not crack or fade in the sunlight. Doesn't become brittle over time due to a higher elasticity than solvent-based paints.
- Release many times fewer volatile organic compounds (VOCs), which can be harmful to the environment, animals and humans in large exposure conditions.
- Less likely to mildew. The oils that are used in solvent-based paints feed mildew and actually encourage its growth.
- Improved colour retention. Oil based paints fade and chalk with time, whereas water based paints retain a better colour throughout.

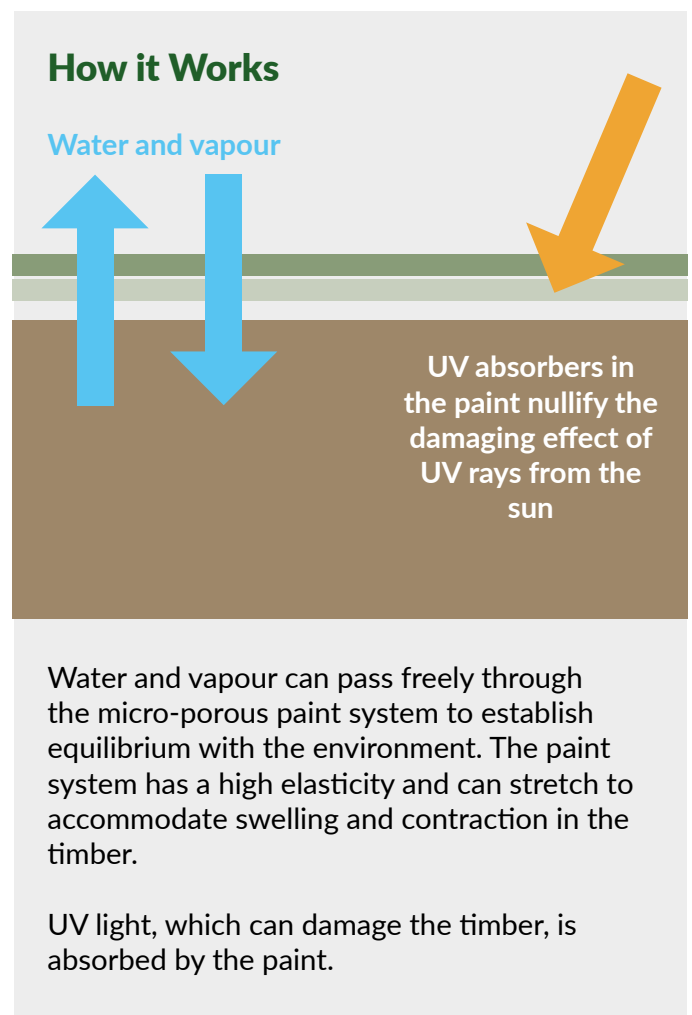



Classic Range

Traditional features combined with innovative construction and design means you can have the home of your dreams with minimal maintenance schedules and industry-leading performance and energy efficiency.

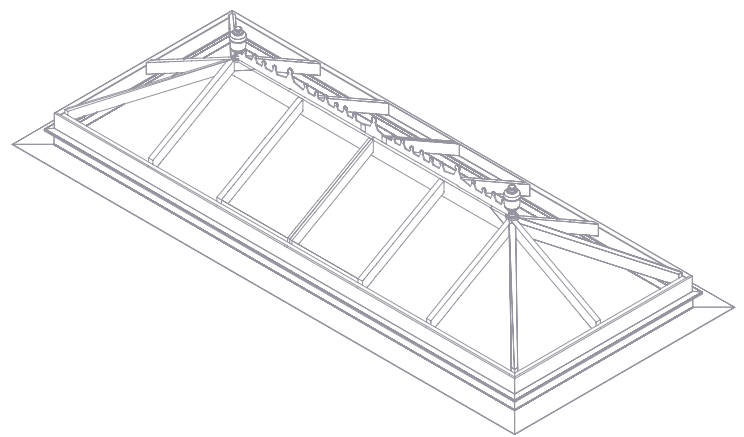

In this section

Case Studies	24
The Chatsworth, Sliding sash window	32
The Hardwick, Flush casement window	34
The Wollaton Mock Sash window	36
The Kedleston, Tilt and turn window	38
The Melbourne, Single, Stable and French doorsets	40
The Peveril, Lift and slide door	42
The Tutbury, Bifolding door	44

Case Study

White Cottage

Nottinghamshire

Gowercroft were approached to provide replacement timber windows for White Cottage in Plum Tree. This unusual and characterful is set in the Nottinghamshire countryside, only a few miles from our window manufacturing workshop in Derbyshire. The L-shaped property, which originally comprised 3 small white cottages that had been knocked into one. A new brick-built extension was also added to create a single spacious family home. Owners Ginny Hallam and Jon Fryer needed space for their young family, and set about renovating the property, contacting Gowercroft for their replacement windows. As the existing wood-effect PVC-u windows were unsightly, Ginny and Jon looked for replacement timber windows. They wanted high quality sustainable timber windows and doors with a sympathetic, traditional appearance to complement the style of the buildings. The Gowercroft Classic range of Accoya windows and doors were the perfect choice.



“We wanted traditional hand-crafted timber windows and doors with high energy performance and a good guarantee. Gowercroft couldn’t have been more helpful in supplying just what we wanted and making sure that their windows and doors worked perfectly with the various architectural elements of our home.”
Ginny Hallam.



Case Study

North Acre

Dorset

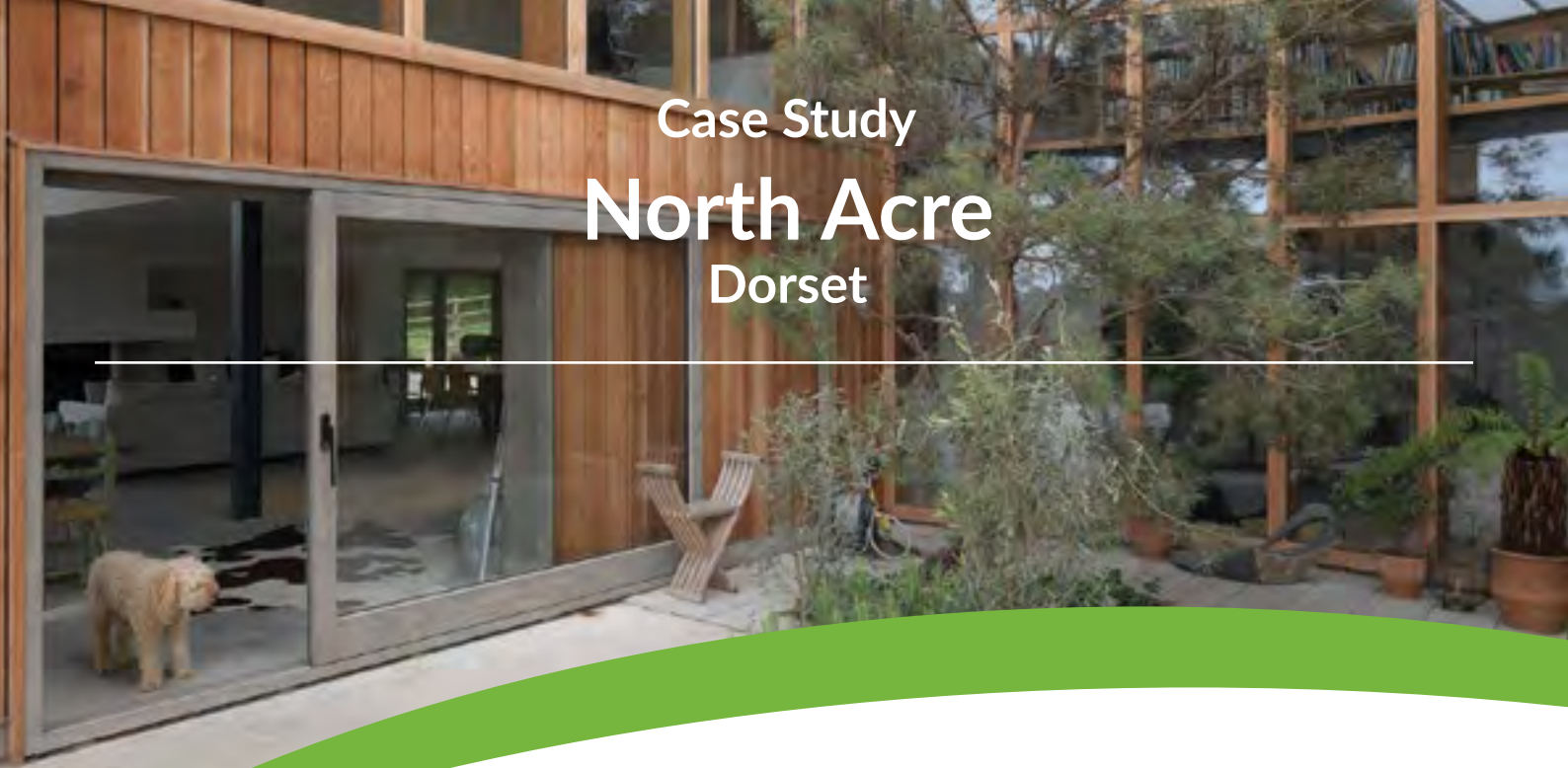

Owners Vanessa & Bruce Jones had always wanted to build their own home in the countryside, so they were delighted when, after a long search, they found a large plot of land with an old disused steel framed agricultural building. The 400 square metre south facing rectangular building, which had previously been used as a cattle shed, had massive potential to be converted into their new dream home. Gowercroft supplied and installed a variety of large sliding doors, screens, doors and windows all in Accoya with a proprietary grey stain to complement the cladded exterior.



“The Gowercroft team went over and above in making sure that no detail was overlooked – both technically and aesthetically – so that their window and doors were the perfect match for our new home.”
Vanessa Jones



Case Study

Canal Side Cottages

Derby

Six disused and derelict 200-year-old cottages in Draycott, Derbyshire have been transformed into a stunning residential development and historical tourist attraction thanks to the tireless work of Derbyshire and Sandiacre Canal Trust and an army of local volunteers! Built in the 1820s on the banks of the old Derby Canal, the original buildings were used for the making of cotton thread. By 1985, the brick buildings had become derelict. Seeing their potential as a heritage attraction, the Trust launched a £ 650k appeal to convert these ramshackle cottages into a vibrant mixed-use complex of three 2-3-bedroom domestic dwellings, a canal side café, and commercial space for leisure companies. The development would also incorporate a museum showing what life was like on the canal and at the Mill for its workers in years gone by. Although constructed to modern building standards, traditional and sympathetic products and materials were sourced where possible from local suppliers. Integral to the restoration was the use of new timber windows, supplied by local windows and doors manufacturer Gowercroft Joinery, which has a long track record of working on heritage and restoration projects.



“The windows and doors have really lifted the building and helped to bring it back to life. We had a great working relationship with the team at Gowercroft, who delivered excellent products to the required schedule – they were a great partner in the project.”

Chris Madge, Chairman of the Derby and Sandiacre Canal Trust.

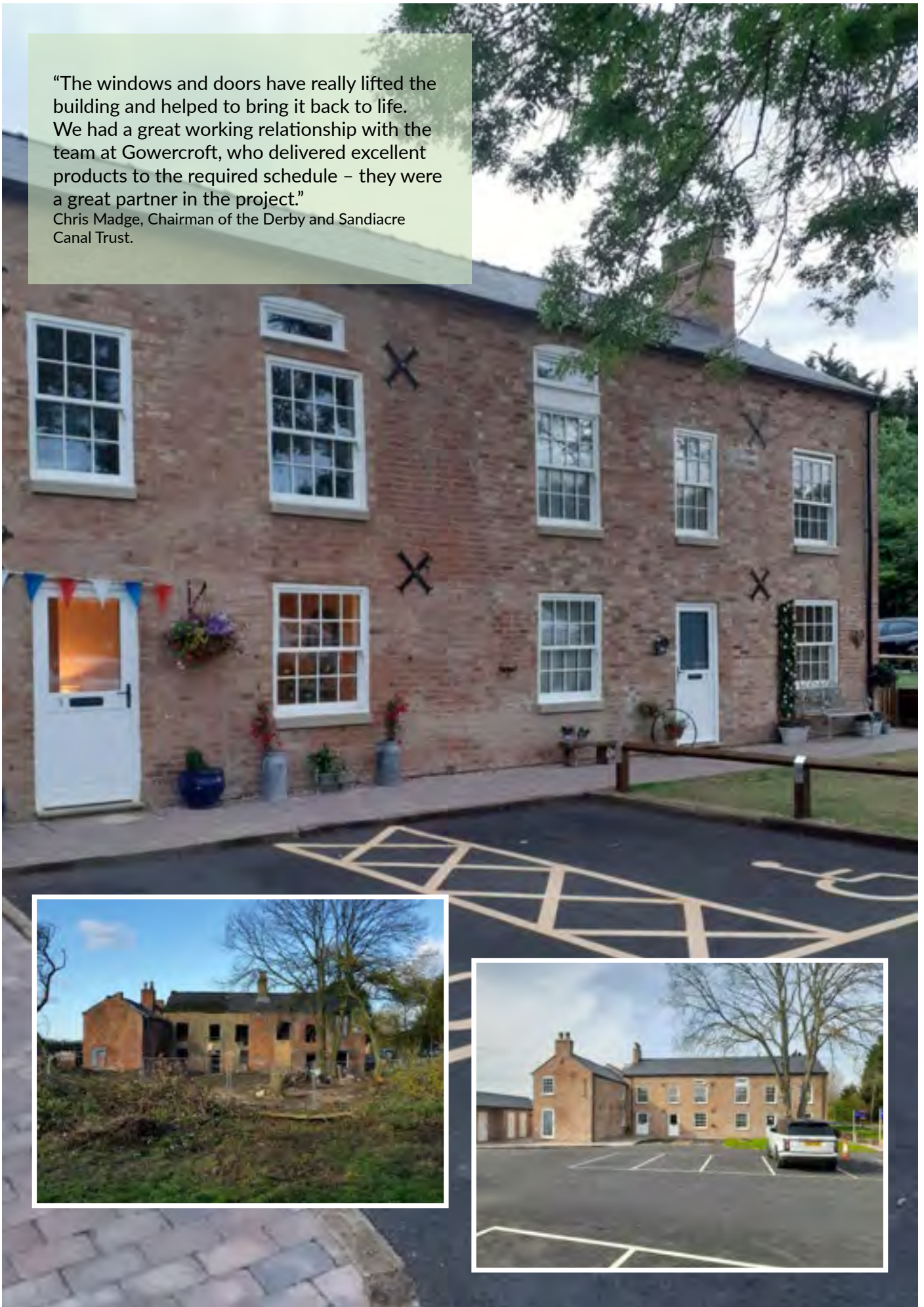

Case Study

West Barn

Derbyshire

West Barn in Somersall, Chesterfield is a beautiful four bedroomed detached barn conversion, with a stream running alongside, in the tranquil Derbyshire countryside. Situated in a conservation area on the outskirts of Chesterfield, the Grade II barn, which formed part of a group of buildings originally belonging to Derbyshire's Somersall Hall, is thought to date back to 1631. When Barry Corker bought the property in 2015, he had plans to significantly upgrade an earlier conversion made in the 1980s, to create a more spacious and light-filled interior, whilst keeping within strict planning requirements and Listed Building consent.

With our experience in restoration and conservation of listed properties, Gowercroft Joinery, was appointed to replace almost all existing softwood windows with larger timber casement windows split by muntins to replicate the original style while maximising glass sightlines. These were supplied with sympathetic narrow Accoya® timber frames in a durable split paint and stain finish. At the back of the building, where there had originally been a two storey high shed door leading into the threshing barn, the existing single patio door was replaced with fully glazed bi-fold doors, stretching across the width of the entire wagon entrance with Accoya® cladding above.





“The team at Gowercroft were extremely helpful in guiding us through the planning and Listed Building consent. They had the skill and craftsmanship to adapt their standard range of windows to the bespoke requirements of the project, enabling us to maintain a sympathetic appearance entirely in keeping with this historic property and its surroundings.”
Barry Corker, Owner.



Classic Range

The Chatsworth

Sliding Sash Window

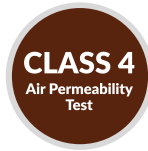

Sash windows have been used in Britain since the 17th Century. Their well-balanced proportions and traditional appearance add character and elegance to any building.

Our flagship Chatsworth range of Sliding sash windows combines low maintenance, longevity, and excellent draught-proofing, with a classic appearance. For additional authenticity, the range is available with either spiral balances or a traditional weights and pulleys system.



Key Features

- Patented SashSealer technology delivering the only Class 4 Air Permeability, traditional sliding sash window on the market. Weights and pulley window has proprietary pocket seal to reduce draughts through the sash pulleys.
- Fully concealed trickle ventilation through the head of the frame is invisible on the internal or external face of the product.
- Traditional horn detailing to the top sash as standard. Options to have variation on the horn detail, or to add a horn to the bottom sash. External staff bead detail on the outer lining for traditional appearance.
- All traditional shapes and sizes are available including curved heads, curved top rail of top sash and double or triple coupled sashes.
- Traditional ironmongery is included with a range of finishes. This includes Angel Sash limiters and recessed finger pulls as standard.
- Spiral balance system includes balance covers as standard to avoid ugly exposed plastic balancer.
- Weights and pulley sashes include articulated lead and concealed access panels for easy maintenance and repair.
- Product exceeded destructive testing to Part Q standards with no amendments or upgrades.
- Available in double or triple glazing, with the ability to deliver A+ rated products with U-values of below 1.0W/m²K.

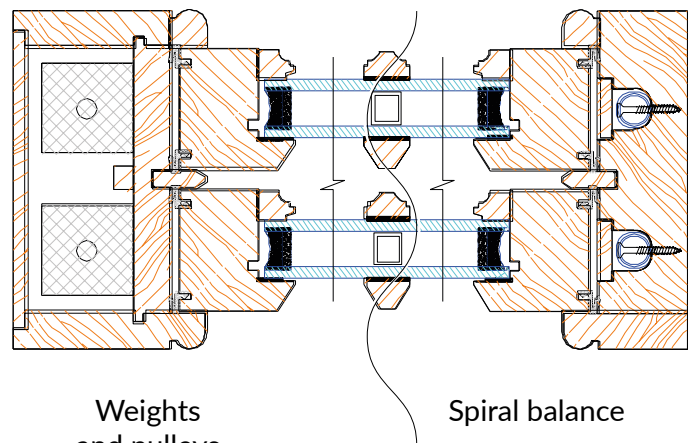

Classic Range

The Hardwick

Flush Casement Window

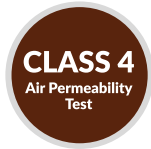

Flush casement windows have featured in buildings dating back to the 16th century, prominently featuring in farmhouses and cottages.

Our Flush Casement windows have a number of modern features that differentiate them from the windows of the 16th century, but these have been implemented with a goal of maintaining the general proportions and sightlines wherever possible. The result is a product that delivers exceptional while still appearing to be a traditionally-styled product.



Key Features

- Double gasket around the entire sash delivers exceptional air-tightness. This is achieved without undermining the appearance of the window.
- Fully concealed trickle ventilation through the head of the frame is invisible on the external face of the product, with the internal vent recessed to reduce its impact.
- All traditional shapes and sizes are available including arched tops, curved tops, bay windows and coupled frames.
- Full multi-point locking system on all products with night ventilation facility. Option to upgrade to Part Q compatibility with stabiliser plates and security keeps.
- Key lockable espagnolette ironmongery is available in a range of heritage and contemporary styles and finishes.
- Adjustable egress friction hinges allow sliding to centre for easy clean functionality. Having no visible hinges on the product when closed improves both security and appearance.
- We include dummy sashes as standard to give a balanced look of non-opening parts of the window.
- Available in double or triple glazing, with the ability to deliver U-values of below $1.0W/m^2K$.

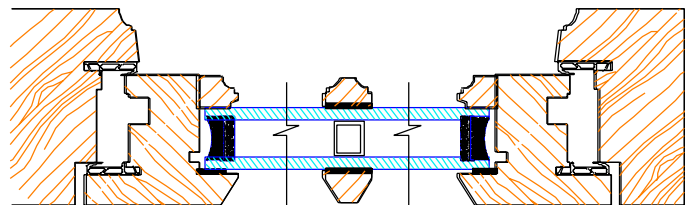

Classic Range

The Wollaton

Mock Sash Window

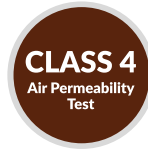

Mock sliding sash windows are designed to match the proportions and aesthetic of a traditional vertical sliding sash window, but with the top sash opening outwards on casement hinges. Mock sash windows can be useful in applications where the wall thickness is not great enough to allow a full box sash window. The outward, top opening functionality can give increased security and easy high-level ventilation, but it is often unsuitable for new build homes due to the difficulty of escape.

Our Wollaton Mock Sash windows have been designed with the top and bottom elements of the window in different planes to match closely to the aesthetic of our Chatsworth vertical sliding sash window, but most Mock sash windows are made in a single plane with slightly over-hanging horns. These two products are very different and cannot be compared in price or quality. This product delivers exceptional draught proofing, energy efficiency and security, while still appearing to be a traditionally-styled product.



Key Features

- Double gasket around the entire sash delivers exceptional air-tightness. This is achieved without undermining the appearance of the window.
- Fully concealed trickle ventilation through the head of the frame is invisible on the external face of the product, with the internal vent recessed to reduce its impact.
- All traditional shapes and sizes are available including arched tops, curved tops, bay windows and coupled frames.
- Full multi-point locking system on all products with night ventilation facility.
- Key lockable espagnolette ironmongery is available in a range of heritage and contemporary styles and finishes.
- Adjustable egress friction hinges allow sliding to centre for easy clean functionality. Having no visible hinges on the product when closed improves both security and appearance.
- We include dummy sashes as standard to give a balanced look of non-opening parts of the window.
- Available in double or triple glazing, with the ability to deliver U-values of below 1.0W/m²K.

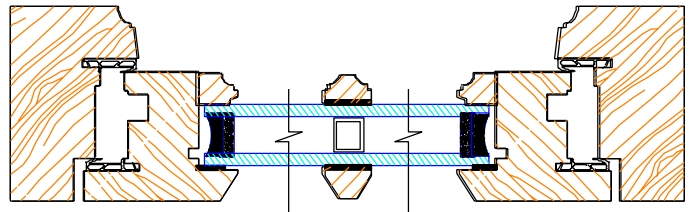

Classic Range

The Kedleston

Tilt and Turn Window

10 YEAR
No Maintenance
Paint
Warranty

5-8 YEAR
No Maintenance
Stain
Warranty

10 YEAR
Warranty on
Workmanship &
Materials

**PART L
COMPLIANT**
High Energy
Efficiency

Tilt and turn products are very popular on the continent. Their slender profiles and large maximum sash sizes suit modern style buildings and allow greater vistas than traditional casement windows. They are inward opening side-hung windows with a secure inward tilt function for ventilation.

At Gowercroft, we search the world to bring our customers new and interesting designs. Our Kedleston Tilt and Turn windows have an over-rebated styling, which looks stunning in contemporary new builds. Modern locking bars and hinges surrounding the entire sash offers enhanced security.



Key Features

- Locking around the entire perimeter of the frame gives enhanced security performance.
- Integrated water-bar system to ensure weather-tightness despite the inward opening functionality.
- Sophisticated ironmongery allows considerably larger opening casements than the traditional outward opening system. This allows a wider variety of designs and a more modern appearance.
- All products can be securely locked in an inward tilt to allow ventilation at night. The product will be rain-proof in this position in all but the most severe weather.
- Key lockable espagnolette ironmongery is included with a range of finishes.
- We include dummy sashes as standard to give a balanced look of non-opening parts of the window.
- Available in double or triple glazing, with the ability to deliver products with U values of below $1.0W/m^2K$.

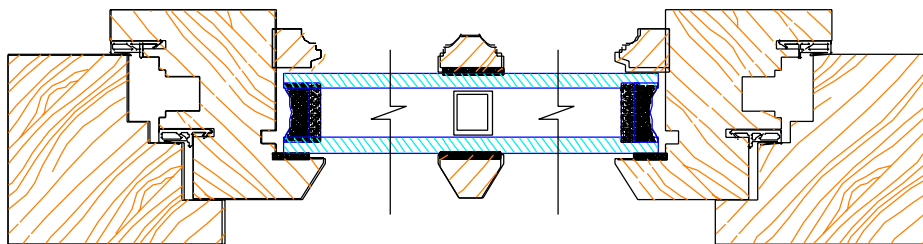

Classic Range

The Melbourne

Single, Stable and French Doors



A well-designed entrance door can give that all important first and lasting impression of quality to any home. An expertly designed and made timber door feels like nothing else and is a real statement throughout the home.

At Gowercroft, we manufacture a whole host of single, stable and French doors, which vary considerably in size, style and functionality, with or without wing lights as required. The quality and performance of the core design remains consistent throughout and incorporates high tech MACO ironmongery systems for enhanced functionality and security.



Key Features

- All traditional shapes and sizes are available, including entrance doors, single doors, French doors and stable doors.
- All panels are constructed using insulated sandwich boards. This delivers a considerable improvement in energy efficiency over traditional doors without impacting the appearance.
- Full multi-point locking system. These locks deliver good security and help to prevent bow or twist in the door leaf during acclimatisation.
- Ironmongery is included with a range of modern and heritage styles and finishes. French doors include cabin hooks as standard.
- High quality ball-bearing butt hinges give long life span and excellent functionality. We include shims behind the hinges for easy adjustment during installation or acclimatisation.
- Clapping strips included as standard on French door-sets delivers exceptional air-tightness.
- We include dummy top and bottom rails as standard in side panels.
- Door leaves made from Accoya® as standard to give extreme stability and reduce the need for seasonal adjustment.

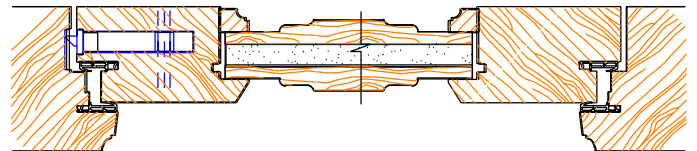

Classic Range

The Tutbury

Bifolding Door



Initially developed in Australia, sliding folding doors have become a popular feature of large new build and renovation projects in the U.K. Often used in the open-plan environments, bifolding doors help create a seamless flow between interior living spaces and the outdoors.

We use Centor ironmongery, which is widely considered to be the best available on the market, combined with intermittent push locking for additional security. The ironmongery system allows a run of doors to concertina together to one end, to give a wide opening. Tutbury bifold doors are available in either a top rolling or bottom rolling depending on the application.



Key Features

- The main access door has full multipoint locking, while every second junction between doors leafs also give top and bottom locking through a push pad in the centre of the door height.
- Key lockable ironmongery is included with a range of finishes. Magnet included to secure door leafs.
- Available in double or triple glazing, with the ability to deliver products with U-values of below 1.0W/m²K.
- Proprietary timber cill with concealed drainage system.

What are the advantages over a lift and slide door?

- 1 Typically offers a single or double access door, which can make it more suitable for everyday use.
- 2 Doors can be concertinaed to give a full opening width.
- 3 There are a greater variety of options available, including curved systems and ones that allow full opening of a corner.
- 4 The door leafs are limited to 1.1m wide, so the product looks traditional in U.K. buildings.



Classic Range

The Peveril

Lift and Slide Doors



Originating on the continent, lift and slide doors lift up and away from the track and can slide effortlessly behind a side panel or next door. These products are popular on modern new builds or in contemporary extensions to older properties.

Our Peveril doors are manufactured around a very high specification ironmongery system from MACO and were carefully designed to maximise glass sightlines. When the handle is rotated, a very heavy door (up to 400kg) can be moved with minimal effort, allowing for much larger door leaves to be installed. These products are popular on modern new builds or in contemporary extensions to older properties.



Key Features

- Locking around the entire perimeter of the frame gives enhanced security performance. Key lockable ironmongery is included with a range of finishes.
- Sophisticated ironmongery allows very large door leaves (up to 3.2m wide) and long runs of up to 19.8m in a 6 door system.
- With the correct building works doors can open and slide into a pocket in the wall, further reducing obstructions.
- Available in double or triple glazing, with the ability to deliver products with U-values of below 1.0W/m²K.
- Panoramic design removes top and bottom rails from side panels to give a more contemporary appearance and better performance.

What are the advantages over a bi-folding door?

- 1 Large unobstructed vistas.
- 2 Increased surface area of glazing gives superior energy efficiency.
- 3 Doors slide between one another and do not protrude into the outdoor space.
- 4 Can be a more cost effective solution over a long run of doors.
- 5 Flexibility of design.

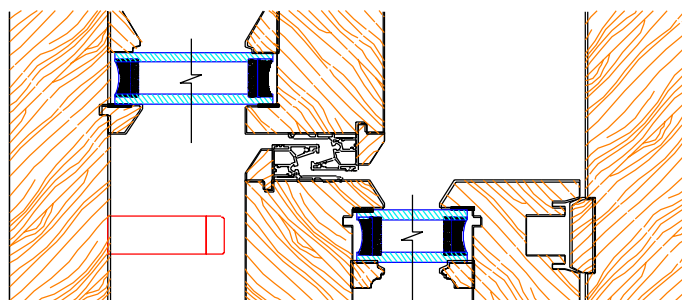



The Heritage Range

An award-winning range of windows and doors, perfect for old cottages, Listed properties or those in conservation areas, due to their thin sections, traditional ironmongery and ultra-slim vacuum glazing.



The products in the Heritage range are based around a highly efficient vacuum glazing unit. The technology behind these glass units is well established, but it has only recently become commercially viable in windows and doors. It offers great opportunity in the Heritage market with extreme heat retention and sound-proofing, delivered in an ultra-slim 8.3mm unit thickness. This allows new windows and doors to greatly improve the performance of conservation and Listed properties, without undermining the appearance or lifespan of the products.

We were the first window and door manufacturer in the UK to embrace vacuum glazing in 2014 and have years of experience in handling and designing products around these units.

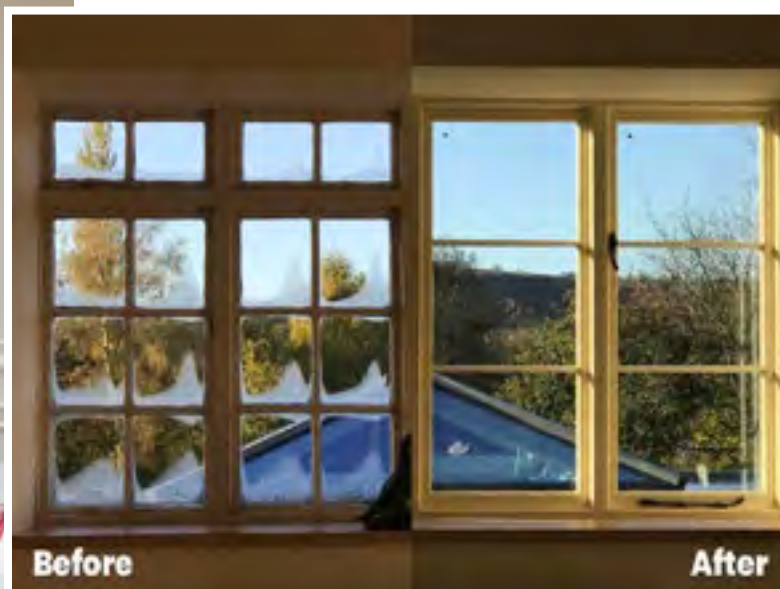

Why we have picked LandVac vacuum glass over the competitors:

- The only vacuum glass to be toughened as standard, reducing the chance of thermal cracking. It also reduces surface distortion apparent in non-toughened vacuum glass, and means that no filming is required, which can undermine the look and longevity of vacuum glass.
- Wide range of shape options.
- Best energy efficiency in the market.
- Largest sizes available - up to 15.m x 2.5m
- Plugs and getters are located in the perimeter and concealed by our shuffle glazed system.
- 15 year unit warranty and exceptionally low breakdown rates.

Internal condensation between single and vacuum glazing.

In this section

Case Studies	48
The Winston, Sliding sash window	56
The Richmond, Flush casement window	58
The Belton, Yorkshire sliding sash window	60
The Clement, Hopper casement window	62
The Churchill, Single, Stable and French doorsets	64
The Halifax, Bifolding door	66

Case Study

Templeton House

Richmond Park, London



The Amazing and Exclusive Restoration of Templeton House

Once the home to former prime minister Sir Winston Churchill, the 240-year old Georgian mansion on the edge of Richmond Park, has the air of an eighteenth-century period drama and has even been used as a lavish filming location for the TV drama 'Downton Abbey'. The property has been used as a family home, field hospital and university halls of residence, before eventually falling into neglect and disrepair. In 2010, David and Laura Rich-Jones purchased the faded stately home with a view to restoring its historic grandeur, whilst offering 21st century standards of comfort and luxury. The large classic sliding sash windows, which characterise the magnificent Georgian façade were central to this endeavour. As they were largely degraded, the challenge was to find sympathetic and authentic looking replacements, which would also offer modern standards of energy efficiency and comfort. After extensive research and development, Gowercroft Joinery, who were supplying much of the specialist joinery and craftsmanship throughout the mansion, produced a radically new but historically sensitive solution. This was rolled into a variety of doors and casement windows to complete the property during a painstaking 9-year refurbishment.



“The concepts of stewardship and authenticity are very important to us. We didn’t want to create a stuffy old museum, but to breathe fresh new life and vitality into this splendid family home in a way that would honour its illustrious past and safeguard its future. Thanks to the dedication and passion of our hand selected team of experts, craftsman and suppliers, we believe we have once more set new standards within the industry.”
David Rich-Jones, Richstone Properties.



Case Study

Mews House

West London



Constructed in 1878, as a traditional carriage house with classic stable doors, this property within a Conservation area once accommodated horse stalls and a hansom cab, with a hayloft and living quarters for the groomsmen in the upper storey. However, over the years, its piecemeal conversion to residential use had resulted in dark, poorly heated, badly laid out rooms and tired exterior facades. Architects Prewett Bizley's aim was to completely remodel the interior into an inspirational light-filled open plan living space, enhance its external appearance within the local conservation area setting, and to drastically reduce the carbon footprint of this draughty nineteenth century property to better than that of a newly build home. A total of 16 Winston Sliding Sash windows of varying sizes were installed. Traditional timber joinery features incorporated into the standard range, including 18mm glazing bars, traditional fitch fasteners, pulleys and sash limiters, concealed gaskets, and period ironware, delivered a ready-made authentic appearance. A landmark in heritage retrofit, the Mews House achieved a massive 82% measured reduction in the overall energy consumption (from 325 to 51kWhr/m2yr). Remarkably the current measured energy use is less than 2025 RIBA targets for new build houses.

“As the strategy for energy reduction was focussed on reducing heating demand, the replacement sash windows were absolutely central to achieving this, both from a U value point of view and reducing air infiltration. What’s amazing when people visit is that they are totally convinced the windows are original and single glazed.”

Bob Prewett, Prewett Bizley Architects



2022 RIBA
Regional Award
Winner



2022 AJ Retrofit
Best House under
£500K Winner



2022 RIBA
House of the
Year Shortlist



2022 Retrofit
Academy
Awards Highly
Commended



Case Study

Harvington Hall Farm

Kidderminster

Harvington Hall Farmhouse is a Grade II Listed property set just to the east of Harvington Hall, the beautiful fourteenth century Grade I listed moated manor house near Kidderminster. The old farmhouse, which has brick elevations set around a traditional timber framework, is believed to date from the 17th and 18th centuries. Meanwhile the adjacent timber framed barn is thought to have been built around the same time. Parts of the farmhouse had been remodelled in the 18th century, extended in the mid-19th century with some late 20th century alterations. The most recent changes included low quality softwood casement windows with glazing bars. There were also steel side hung casement windows from the 1950s. These had no historical significance and were generally in poor condition. The first phases of the project are now complete with total replacement of 25 Richmond casement windows and two heritage-style door sets all featuring Heritage vacuum glazing. The impact of these changes to the fabric of the building has been unquestionable as these high quality Accoya™ windows bring a unity to the fenestration, as they replace an assortment of very basic softwood 'infill' windows and an Aluminium door set currently installed.

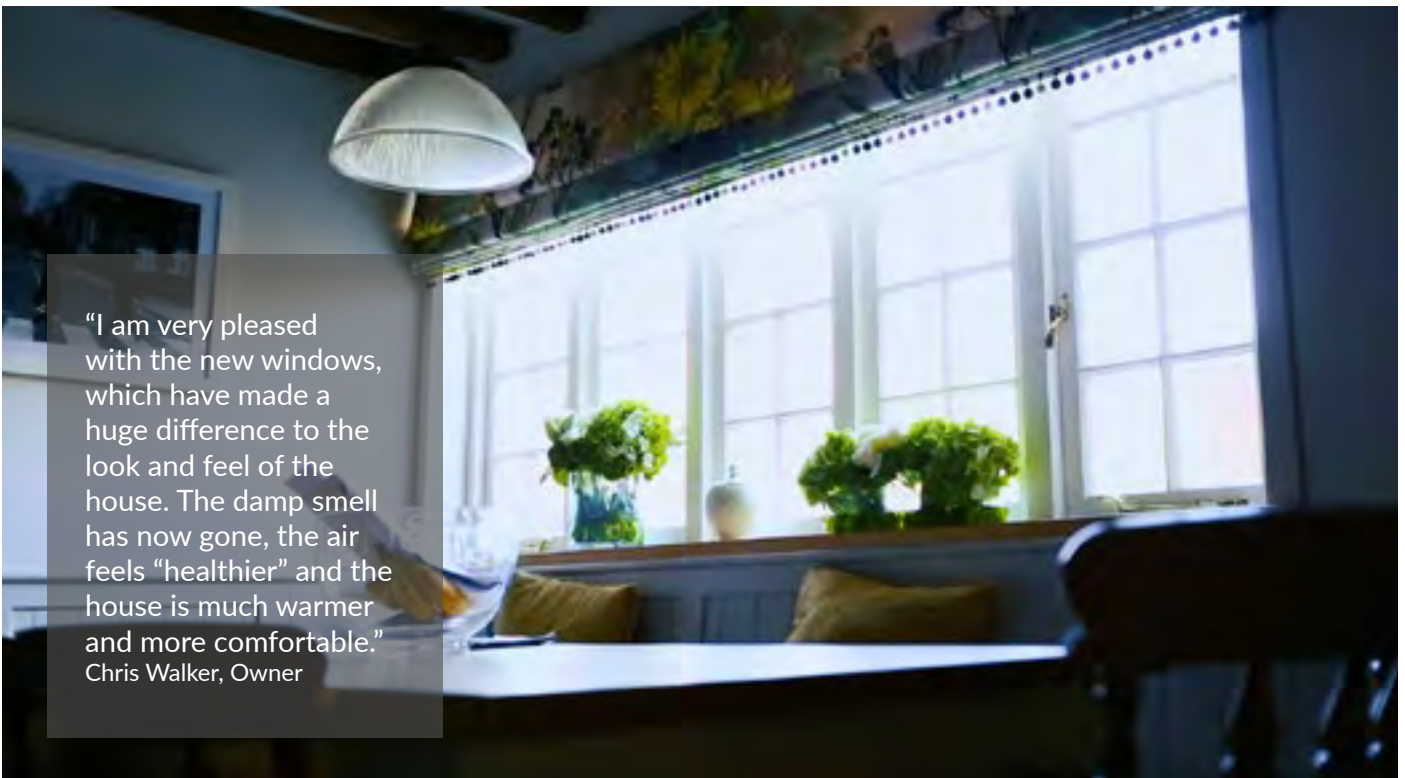

"I am very pleased with the new windows, which have made a huge difference to the look and feel of the house. The damp smell has now gone, the air feels "healthier" and the house is much warmer and more comfortable."
Chris Walker, Owner



Case Study

The William White Buildings

Staffordshire

The William White Buildings are a well-known feature in the historic village of Audley in Staffordshire.

Situated on Church Street, the row of three storey Gothic-design buildings, linked by an archway to a smaller house was designed in 1855 by William White, a distinguished architect known for his Gothic revival architecture and church restorations. Originally designed as a set of shops with an arched arcade, their red brick facades, with traditional bond patterns and bands of darker bricks, are made distinctive by the series of alternate narrow and wide pointed ground floor arches. When Robert Walker bought the middle Grade II listed property in 2006 as a four bedroomed family home, it was badly in need of restoration, with stairs that were rickety, floorboards and windows that were badly degraded and a damp-proof course and air bricks also needed to be installed. Gowercroft Joinery supplied six Richmond casement windows with delicate astragal bars for the front and back of the property from their Heritage range, which has been designed specifically to suit old and listed properties. To keep to the original aesthetic, the replacement casements were fitted flush with the internal arch, which required some of the brickwork to be removed and then refitted round the windows.



“We’re particularly impressed with the LandVac vacuum glazing and the difference it has made to our quality of life. Even though the glass unit is so very slim and light, it has the energy efficiency of triple glazing and we’ve noticed a palpable difference in the warmth of our home!”
Robert Walker, Owner





Heritage Range

The Winston

Heritage Sliding Sash Window

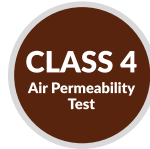

Sash windows have been used in Britain since the 17th Century. Their well-balanced proportions and traditional appearance add character and elegance to any building.

Our Winston range of Sliding sash windows was designed to incorporate a number of highly traditional features but by utilising modern design and materials, we have also been able to deliver exceptional performance. This product comes with our full 10-year guarantee on all elements and delivers energy efficiency ratings as good as modern double-glazed products.



Key Features

- Manufactured from Accoya®, the best longevity of any timber together with exceptional energy efficiency.
- Vacuum cavity glazing, delivering U-values comparable with modern double glazing, but with a total thickness of only 8.3mm. No double reflection makes it perfect for use in conservation areas. LandVac glazing is also toughened as standard for safety and security.
- Patented SashSealer technology delivering the only Class 4 Air Permeability, traditional sliding sash window on the market. Weights and pulley window has proprietary pocket seal to reduce draughts through the sash pulleys.
- Traditional fitch fasteners, pulleys and sash limiters in a range of styles and finishes. Hung on traditional lead weights as standard, but also available with concealed spiral balances.
- Slender 22mm glazing bars and thin profile of the windows reduce the perceived width of the sections. External bar designed to replicate the traditional appearance of putty pointing.
- Most heritage products have greatly reduced warranties, but ours come with our full 10-year guarantee and are eligible for TimbaCare.

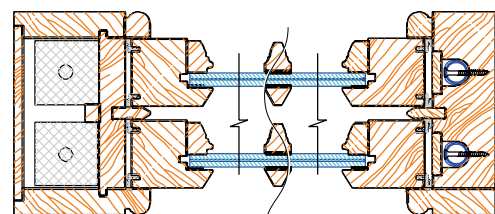

Weight and pulley

Spiral balance

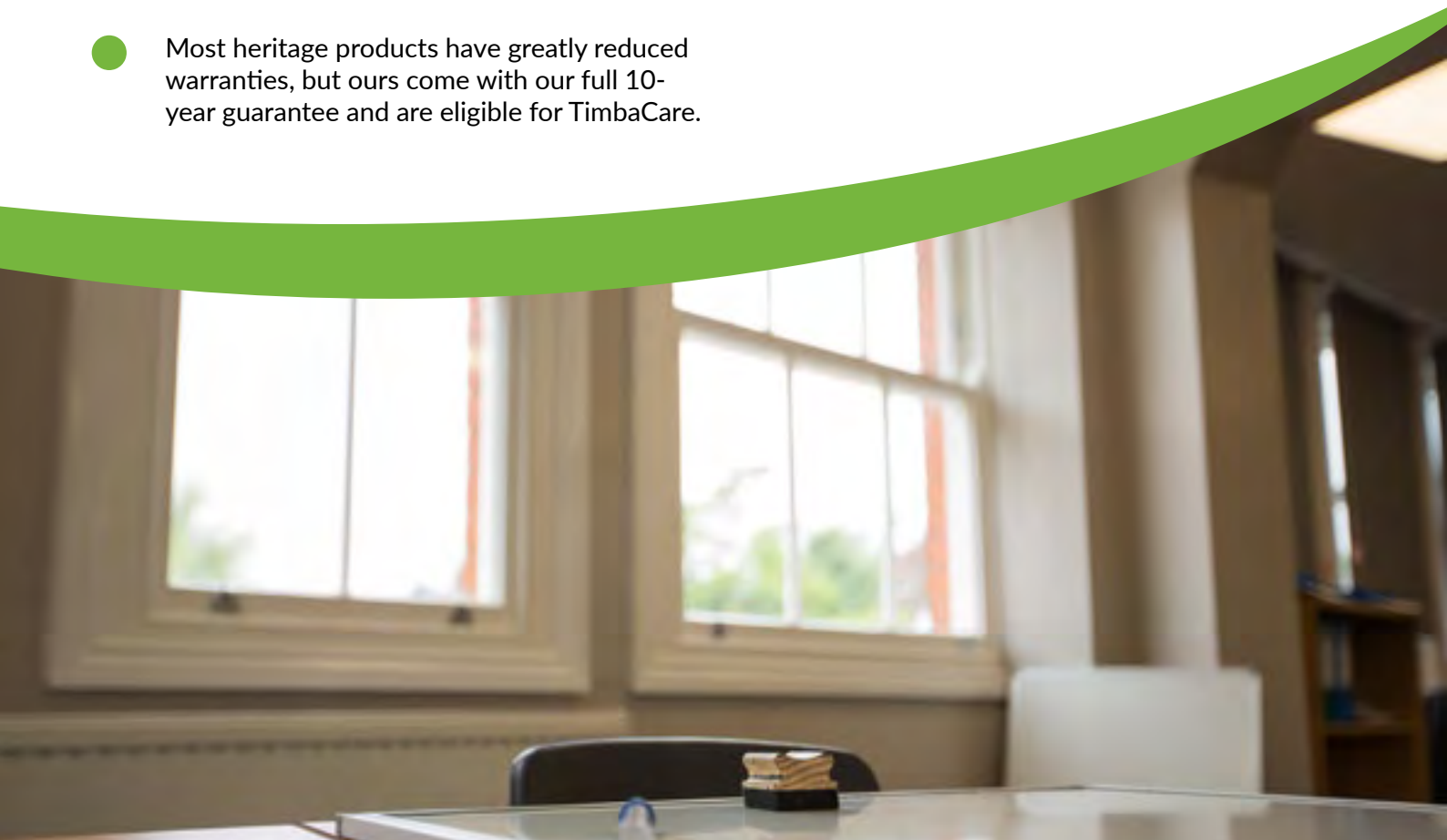



Heritage Range

The Richmond

Heritage Casement Window



Flush casement windows can be seen on country farmhouses and cottages dating back to the 16th century. This window design is highly versatile and can be made in a variety of fenestration patterns so they are a perfect fit for your home.

Our Richmond range of flush casement windows was designed to incorporate a number of highly traditional features but by utilising modern design and materials, we have also been able to deliver exceptional performance. This product comes with our full 10-year guarantee on all elements and delivers energy efficiency ratings as good as modern double-glazed products.



Key Features

- Manufactured from Accoya®, the best longevity of any timber together with exceptional energy efficiency.
- Vacuum cavity glazing, delivering U-values comparable with modern double glazing, but with a total thickness of only 8.3mm. No double reflection makes it perfect for use in conservation areas. LandVac glazing is also toughened as standard for safety and security.
- Fully concealed gaskets, designed into the frame.
- Traditional butt hinges are combined with concealed espagnolette locking and compatible handles. Handles and stays are available in a range of styles and finishes.
- Slender 22mm glazing bars and thin profile of the windows reduce the perceived width of the sections. External bar designed to replicate the traditional appearance of putty pointing.
- Most heritage products have greatly reduced warranties, but ours come with our full 10-year guarantee and are eligible for TimbaCare.

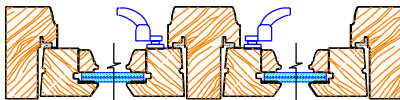

Heritage Range

The Belton

Horizontal Sliding Sash Window



These windows are most common in the North of the country and are often referred to as Yorkshire Sliding Sash windows or Yorkshire Sliders for this reason. Often, these windows have been replaced with flush casement windows due to their improved draught-proofing.

Our Belton range of Sliding sash windows was designed to incorporate a number of highly traditional features but by utilising modern design and materials, we have also been able to deliver high performance. This product comes with our full 10-year guarantee on all elements and delivers energy efficiency ratings as good as modern double-glazed products.



Key Features

- Manufactured from Accoya®, the best longevity of any timber together with exceptional energy efficiency.
- Vacuum cavity glazing, delivering U-values comparable with modern double glazing, but with a total thickness of only 8.3mm. No double reflection makes it perfect for use in conservation areas. LandVac glazing is also toughened as standard for safety and security.
- Traditional fitch fasteners and sash limiters in a range of heritage finishes.
- Slender 22mm glazing bars and thin profile of the windows reduce the perceived width of the sections. External bar designed to replicate the traditional appearance of putty pointing.
- Horizontal track and gasket system designed to maximise weather tightness without impacting the traditional appearance.
- Most heritage products have greatly reduced warranties, but ours come with our full 10-year guarantee and are eligible for TimbaCare.

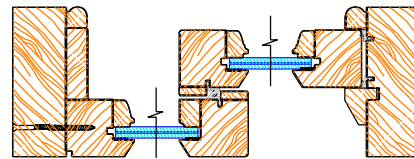

Heritage Range

The Clement

Heritage Hopper Casement Window



Hopper windows are traditionally found in barns and stable blocks, they were used in barns to keep high level airflow over livestock. They look much like a regular casement window but are hinged at the bottom, open inward and feature a fanlight catch and a restrictor to set the maximum opening.

Our Clement range of hopper casement windows was designed to incorporate a number of highly traditional features but by utilising modern design and materials, we have also been able to deliver high performance. This product comes with our full 10-year guarantee on all elements and delivers energy efficiency ratings as good as modern double-glazed products.



Key Features

- Manufactured from Accoya®, the best longevity of any timber together with exceptional energy efficiency.
- Vacuum cavity glazing, delivering U-values comparable with modern double glazing, but with a total thickness of only 8.3mm. No double reflection makes it perfect for use in conservation areas. LandVac glazing is also toughened as standard for safety and security.
- Fully concealed gaskets designed to fit into the frame.
- Traditional butt hinges, fan light catches and arc restrictors in a range of styles and finishes.
- Slender 22mm glazing bars and thin profile of the windows reduce the perceived width of the sections. External bar designed to replicate the traditional appearance of putty pointing.
- Most heritage products have greatly reduced warranties, but ours come with our full 10-year guarantee and are eligible for TimbaCare.

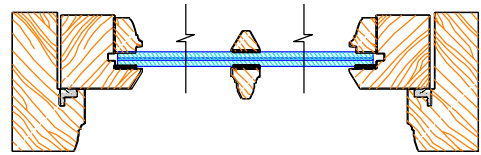

Heritage Range

The Churchill

Single, French and Stable Heritage Doors



A well-designed entrance door can give that all important first and lasting impression of quality to any home. An expertly designed and made timber door feels like nothing else and is a real statement throughout the home.

Our Churchill range of single, stable and French doors was designed to incorporate a number of highly traditional features but by utilising modern design and materials, we have also been able to deliver exceptional performance. This product comes with our full 10-year guarantee on all elements and delivers energy efficiency ratings as good as modern double-glazed products.



Key Features

- Manufactured from Accoya®, the best longevity of any timber together with exceptional energy efficiency.
- Vacuum cavity glazing, delivering U-values comparable with modern double glazing, but with a total thickness of only 8.3mm. No double reflection makes it perfect for use in conservation areas. LandVac glazing is also toughened as standard for safety and security.
- Reduced visibility gaskets designed into the frame.
- All panels are constructed using insulated sandwich boards. This delivers a considerable improvement in energy efficiency over traditional doors without impacting the appearance.
- All traditional shapes and sizes are available including entrance doors, single doors, French doors and stable doors.
- Full multi-point locking system with options to suit all property types. These deliver good security and help to prevent bow or twist in the door leaf.
- High quality ball-bearing butt hinges give long life span and excellent functionality. We include shims behind the hinges for easy adjustment during installation or acclimatisation.
- Ironmongery is included with a range of finishes. French door sets include cabin hooks as standard.
- We include dummy top and bottom rails as standard on fixed side screens.



Heritage Range

The Halifax

Heritage Bifolding Door



Initially developed in Australia, sliding folding doors have become a popular feature of large new build and renovation projects in the U.K. Often used in the open-plan environments, bifolding doors help create a seamless flow between interior living spaces and the outdoors.

Our Halifax range of bifolding doors was designed to incorporate a number of highly traditional features but by utilising modern design and materials, we have also been able to deliver high performance. This product comes with our full 10-year guarantee on all elements and delivers energy efficiency ratings as good as modern double-glazed products.



Key Features

- The main access door has full multipoint locking, while every second junction between doors leaves also give top and bottom locking through a push pad in the centre of the door height.
- Doors are concertinaed to give a full opening width. A single or double access door can be readily used without opening the full door width.
- Key lockable ironmongery is included with a range of heritage finishes. Magnets included to secure door leaves.
- Vacuum cavity glazing, delivering U-values comparable with modern double glazing, but with a total thickness of only 8.3mm. No double reflection makes it perfect for use in conservation areas. LandVac glazing is also toughened as standard for safety and security.
- Proprietary cill with concealed drainage system

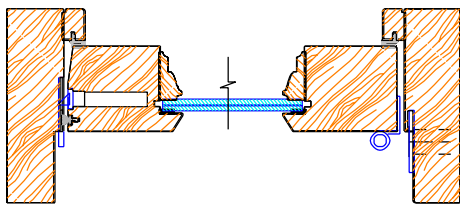



The Frontier Range

Extreme Performance Timber Windows and Doors



Designed to target the future build market, but without the typical downsides of super-efficient products. The Frontier range is our most advanced window range yet. Constructed from FSC-Certified Accoya® with a proprietary vacuum cavity unit and a specially adapted Italian paint system – the Frontier range pushes boundaries.



In this section

The Tatra, Sliding sash window	70
The Acadia, Flush casement window	72
The Kruger, Tilt and turn window	74
The Denali, Single, Stable and French doorsets	76
The Brecon, Bifolding door	78
The Lomond, Lift and slide doors	80

Frontier Range The Tatra Sliding Sash Window

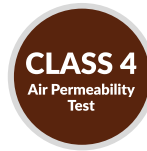

Sash windows have been used in Britain since the 17th Century. Their well-balanced proportions and traditional appearance add character and elegance to any building.

The Tatra sliding sash window was designed around triple glazed vacuum glass. This unit is considerably thinner than effective triple or quadruple glazing units, which allows us to replicate the style and sections of a traditional British sliding sash window, while also achieving extreme energy efficiency. We have also incorporated a highly traditional beading detail to give the windows and doors a timeless and beautiful appearance.

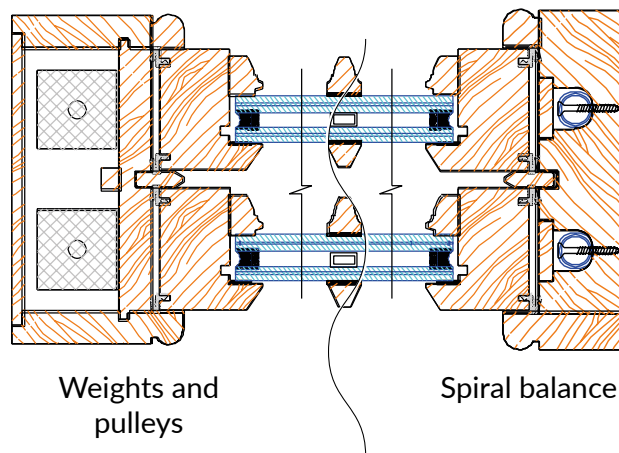

Key Features

- Vacuum cavity glazing combined into a proprietary triple glazed unit, delivering centre pane U-values of 0.4W/m²K. Thinner unit allows for more traditional window dimensions and better aesthetics.
- Manufactured from Accoya, the best longevity of any timber together with exceptional energy efficiency.
- Patented SashSealer technology delivering the only Class 4 Air Permeability, traditional sliding sash window on the market. Weights and pulley window has proprietary pocket seal to reduce draughts through the sash pulleys.
- Fully concealed trickle ventilation through the head of the frame is invisible on the internal or external face of the product.
- Traditional horn detailing to the top sash as standard. Options to have variation on the horn detail, or to add a horn to the bottom sash. External staff bead detail on the outer lining for traditional appearance.
- All traditional shapes and sizes are available including curved heads, curved top rail of top sash and double or triple coupled sashes.
- Slender 22mm glazing bars and thin profile of the beading reduce the perceived width of the sections. External bar designed to replicate the traditional appearance of putty pointing.
- Traditional ironmongery is included with a range of finishes. This includes angel sash limiters and recessed finger pulls as standard.

Ongoing Development

The Tatra Sliding Sashes are continuing to be developed to achieve industry-redefining materials health credentials.

The average number of chemicals used in the average new build home has risen from 50 in 1900 to over 55,000 in a modern home. A classic example of this change can be seen in highly energy-efficient window and door products, where almost all contain a myriad of unnatural, synthesised materials in the form of insulating foams and synthesised coatings. There are reported to be 40,000 deaths each year in the UK due to poor air quality and 2.7% of global diseases are a result of indoor air pollution.

With these startling figures in mind, we set about designing the Frontier Range to be manufactured from natural Accoya timber with no integrated insulation – this required an exceptionally efficient glazing unit to balance the higher conductivity of the frames and we worked with Vacuum Glazing to deliver just that.

We are continuing to work on ventilation and coating systems to further improve the materials' health credentials

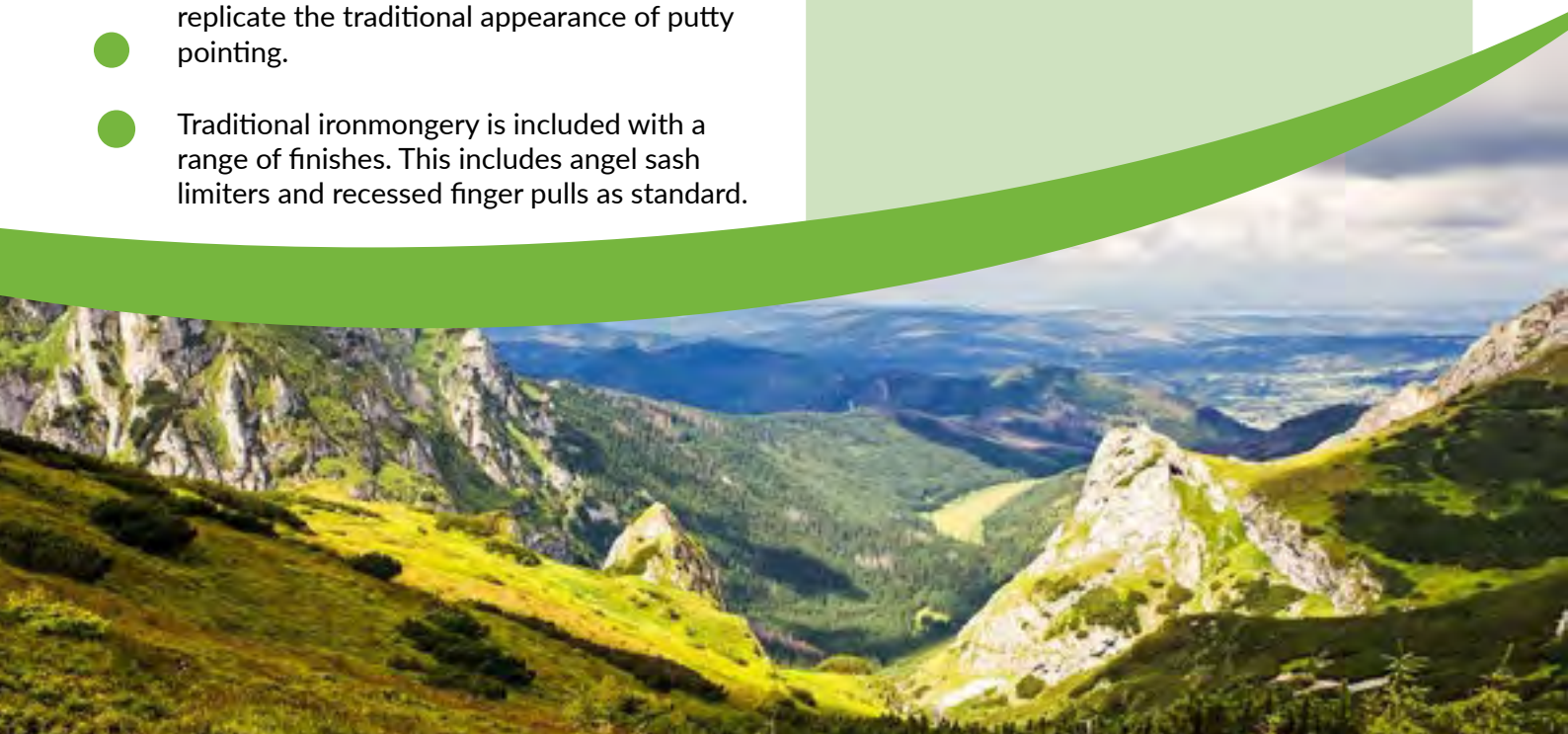

Frontier Range

The Acadia

Flush Casement Window

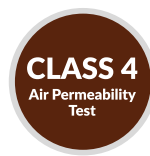

Flush casement windows can be seen on country farmhouses and cottages dating back to the 16th century. This window design is highly versatile and can be made in a variety of fenestration patterns, so they are a perfect fit for your home.

The Acadia flush casement window was designed around triple glazed vacuum glass. This unit is considerably thinner than effective triple or quadruple glazing units, which allows us to replicate the style and sections of a traditional British casement window, while also achieving extreme energy efficiency. We have also incorporated a highly traditional beading detail to give the windows and doors a timeless and beautiful appearance.

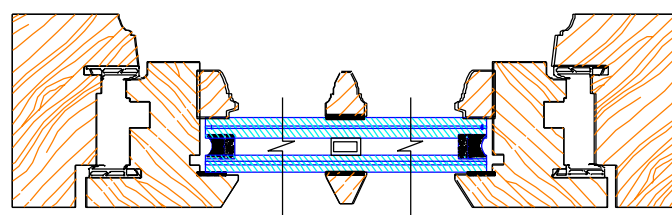

Key Features

- Vacuum cavity glazing combined into a proprietary triple glazed unit, delivering centre pane U-values of $0.4\text{W}/\text{m}^2\text{K}$. Thinner unit allows for more traditional window dimensions and better aesthetics.
- Manufactured from Accoya, the best longevity of any timber together with exceptional energy efficiency.
- Double gasketed system achieving the highest possible classifications of Air Permeability, Resistance to Wind Load and Water Tightness.
- Adjustable egress friction hinges allow full opening width for fire regulations and sliding to centre for easy clean functionality. Having no visible hinges on the product when closed improves both security and appearance.
- Fully concealed trickle ventilation through the head of the frame is invisible on the external face of the product, with the internal vent recessed to reduce its impact.
- All traditional shapes and sizes are available including arched tops, curved tops, bay windows and coupled frames.
- Slender 22mm glazing bars and thin profile of the beading reduce the perceived width of the sections. External bar designed to replicate the traditional appearance of putty pointing.

Ongoing Development

The Acadia Flush Casements are continuing to be developed to achieve industry-redefining materials health credentials.

The average number of chemicals used in the average new build home has risen from 50 in 1900 to over 55,000 in a modern home. A classic example of this change can be seen in highly energy-efficient window and door products, where almost all contain a myriad of unnatural, synthesised materials in the form of insulating foams and synthesised coatings. There are reported to be 40,000 deaths each year in the UK due to poor air quality and 2.7% of global diseases are a result of indoor air pollution.

With these startling figures in mind, we set about designing the Frontier Range to be manufactured from natural Accoya timber with no integrated insulation – this required an exceptionally efficient glazing unit to balance the higher conductivity of the frames and we worked with Vacuum Glazing to deliver just that.

We are continuing to work on ventilation and coating systems to further improve the materials' health credentials

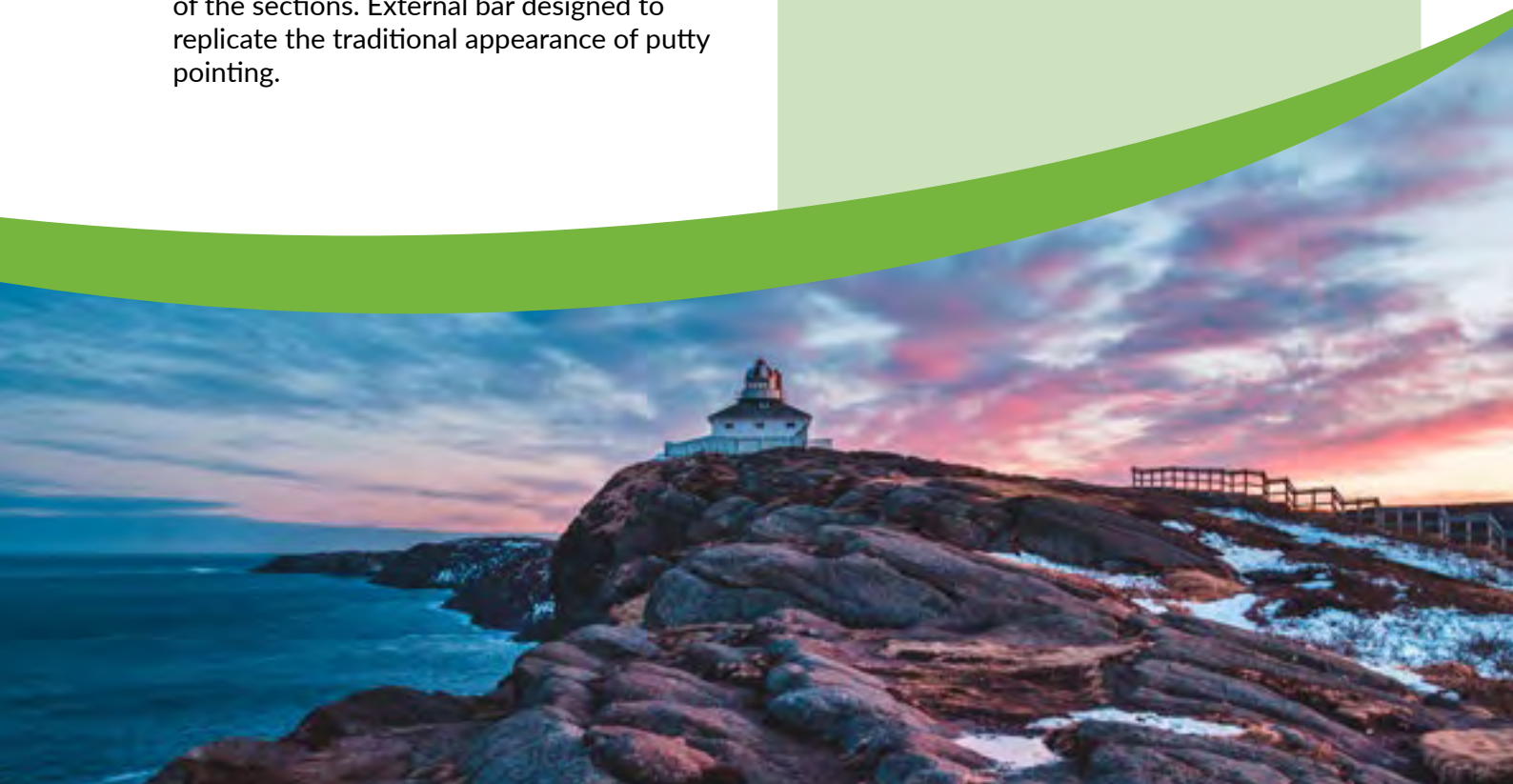

Frontier Range

The Kruger

Tilt and Turn Window

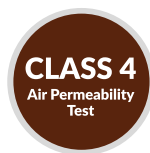

Tilt and turn products are very popular on the continent. Their slender profiles and large maximum sash sizes suit modern style buildings and allow greater vistas than traditional casement windows. They are inward opening side-hung windows with a secure inward tilt function for ventilation.

The Kruger tilt and turn window was designed around triple glazed vacuum glass. This unit is considerably thinner than effective triple or quadruple glazing units, which allows us to minimise the sections and avoid bulky frames, while also achieving extreme energy efficiency. We have also incorporated a highly traditional beading detail to give the windows and doors a timeless and beautiful appearance.

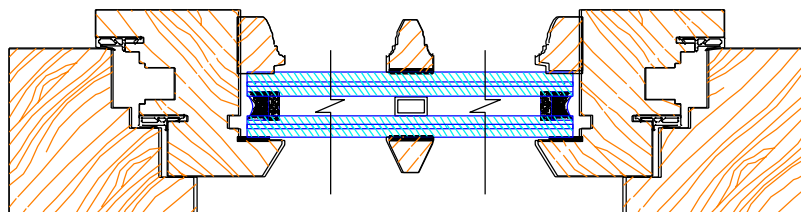

Key Features

- Vacuum cavity glazing combined into a proprietary triple glazed unit, delivering centre pane U-values of 0.4W/m²K. Thinner unit allows for more traditional window dimensions and better aesthetics.
- Locking around the entire perimeter of the frame gives enhanced security performance.
- Integrated water-bar system to ensure weather-tightness despite the inward opening functionality.
- Sophisticated ironmongery allows considerably larger opening casements than the traditional outward opening system. This allows a wider variety of designs and a more modern appearance.
- All products can be securely locked in an inward tilt to allow ventilation at night. The product will be rain-proof in this position in all but the most severe weather.
- Manufactured from Accoya®, the best longevity of any timber together with exceptional energy efficiency.
- Double gasketed system achieving the highest possible classifications of Air Permeability, Resistance to Wind Load and Water Tightness.
- Key lockable espagnolette ironmongery is included with a range of finishes.
- We include dummy sashes as standard to give a balanced look of non-opening parts of the window.
- All traditional shapes and sizes are available in the same profile to deliver consistency throughout the build.
- Slender 22mm glazing bars and thin profile of the beading reduce the perceived width of the sections. External bar designed to replicate the traditional appearance of putty pointing.

Ongoing Development

The Kruger Tilt and Turn windows are continuing to be developed to achieve industry-redefining materials health credentials.

The average number of chemicals used in the average new build home has risen from 50 in 1900 to over 55,000 in a modern home. A classic example of this change can be seen in highly energy-efficient window and door products, where almost all contain a myriad of unnatural, synthesised materials in the form of insulating foams and synthesised coatings. There are reported to be 40,000 deaths each year in the UK due to poor air quality and 2.7% of global diseases are a result of indoor air pollution.

With these startling figures in mind, we set about designing the Frontier Range to be manufactured from natural Accoya timber with no integrated insulation – this required an exceptionally efficient glazing unit to balance the higher conductivity of the frames and we worked with Vacuum Glazing to deliver just that.

We are continuing to work on ventilation and coating systems to further improve the materials' health credentials

Frontier Range

The Denali

Single, French and Stable Doors



A well-designed entrance door can give that all important first and lasting impression of quality to any home. An expertly designed and made timber door feels like nothing else and is a real statement throughout the home.

The Denali single, stable and French doors were designed around triple glazed vacuum glass. This unit is considerably thinner than effective triple or quadruple glazing units, which allows us to replicate the style and sections of a traditional British door profile, while also achieving extreme energy efficiency. We have also incorporated a highly traditional beading detail to give the windows and doors a timeless and beautiful appearance.

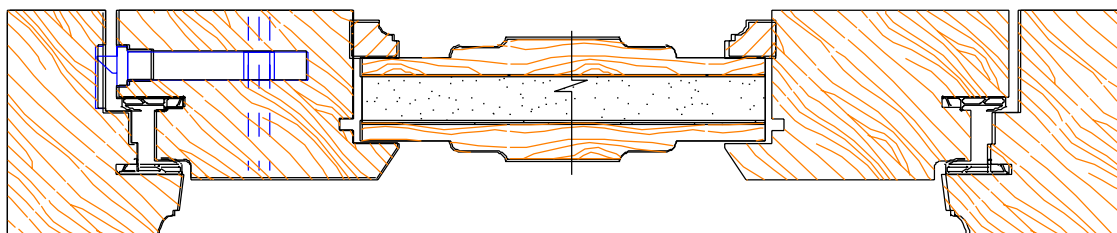

Key Features

- Vacuum cavity glazing combined into a proprietary triple glazed unit, delivering centre pane U-values of 0.4W/m²K. Thinner unit allows for more traditional window dimensions and better aesthetics.
- All traditional shapes and sizes are available, including entrance doors, single doors, French doors and stable doors.
- All panels are constructed using insulated sandwich boards. This delivers a considerable improvement in energy efficiency over traditional doors without impacting the appearance.
- Full multi-point locking system. These locks deliver good security and help to prevent bow or twist in the door leaf during acclimatisation.
- Ironmongery is included with a range of modern and heritage styles and finishes. French doors include cabin hooks as standard.
- High quality ball-bearing butt hinges give long life span and excellent functionality. We include shims behind the hinges for easy adjustment during installation or acclimatisation.
- Clapping strips included as standard on French door-sets delivers exceptional airtightness.
- We include dummy top and bottom rails as standard in side panels.
- Door leafs made from Accoya® as standard to give extreme stability and reduce the need for seasonal adjustment.

Ongoing Development

The Denali Range of Doors are continuing to be developed to achieve industry-redefining materials health credentials.

The average number of chemicals used in the average new build home has risen from 50 in 1900 to over 55,000 in a modern home. A classic example of this change can be seen in highly energy-efficient window and door products, where almost all contain a myriad of unnatural, synthesised materials in the form of insulating foams and synthesised coatings. There are reported to be 40,000 deaths each year in the UK due to poor air quality and 2.7% of global diseases are a result of indoor air pollution.

With these startling figures in mind, we set about designing the Frontier Range to be manufactured from natural Accoya timber with no integrated insulation – this required an exceptionally efficient glazing unit to balance the higher conductivity of the frames and we worked with Vacuum Glazing to deliver just that.

We are continuing to work on ventilation and coating systems to further improve the materials' health credentials

- Slender 22mm glazing bars and thin profile of the beading reduce the perceived width of the sections. External bar designed to replicate the traditional appearance of putty pointing.

Frontier Range The Brecon Bifolding Doors



Initially developed in Australia, sliding folding doors have become a popular feature of large new build and renovation projects in the U.K. Often used in the open-plan environments, bifolding doors help create a seamless flow between interior living spaces and the outdoors.

The Brecon bifolding doors were designed around triple glazed vacuum glass. This unit is considerably thinner than effective triple or quadruple glazing units, which allows us to replicate the style and sections of a traditional British door profile, while also achieving extreme energy efficiency. We have also incorporated a highly traditional beading detail to give the windows and doors a timeless and beautiful appearance.

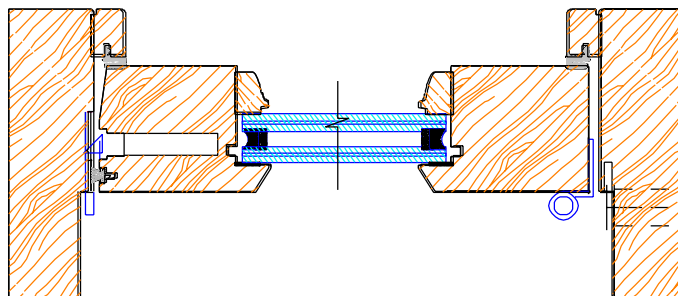

*Part M Cill options to comply with low mobility.

Key Features

- Vacuum cavity glazing combined into a proprietary triple glazed unit, delivering centre pane U-values of $0.4W/m^2K$. Thinner unit allows for more traditional window dimensions and better aesthetics.
- The main access door has full multipoint locking, while every second junction between doors leafs also give top and bottom locking through a push pad in the centre of the door height.
- Key lockable ironmongery is included with a range of finishes. Magnet included to secure door leafs.
- Available in double or triple glazing, with the ability to deliver products with U-values of below $1.0W/m^2K$.
- Proprietary timber cill with sacrificial step and concealed drainage system.
- Slender 22mm glazing bars and thin profile of the beading reduce the perceived width of the sections. External bar designed to replicate the traditional appearance of putty pointing.

Ongoing Development

The Brecon Bifolding Doors are continuing to be developed to achieve industry-redefining materials health credentials.

The average number of chemicals used in the average new build home has risen from 50 in 1900 to over 55,000 in a modern home. A classic example of this change can be seen in highly energy-efficient window and door products, where almost all contain a myriad of unnatural, synthesised materials in the form of insulating foams and synthesised coatings. There are reported to be 40,000 deaths each year in the UK due to poor air quality and 2.7% of global diseases are a result of indoor air pollution.

With these startling figures in mind, we set about designing the Frontier Range to be manufactured from natural Accoya timber with no integrated insulation – this required an exceptionally efficient glazing unit to balance the higher conductivity of the frames and we worked with Vacuum Glazing to deliver just that.

We are continuing to work on ventilation and coating systems to further improve the materials' health credentials

What are the advantages over a lift and slide door?

- 1 Typically offers a single or double access door, which can make it more suitable for everyday use.
- 2 Doors can be concertinaed to give a full opening width.
- 3 There are a greater variety of options available, including curved systems and ones that allow full opening of a corner.
- 4 The door leafs are limited to 1.1m wide, so the product looks traditional in U.K. buildings.

Frontier Range

The Lomond

Lift and Slide Panoramic Doors



Originating on the continent, lift and slide doors lift up and away from the track and can slide effortlessly behind a side panel or next door. These products are popular on modern new builds or in contemporary extensions to older properties.

Our Lomond doors are manufactured around a very high specification ironmongery system from MACO and were carefully designed to maximise glass sightlines. The Lomond doors were designed around triple glazed vacuum glass to give extreme energy efficiency. We have also incorporated a highly traditional beading detail to give the windows and doors a timeless and beautiful appearance.

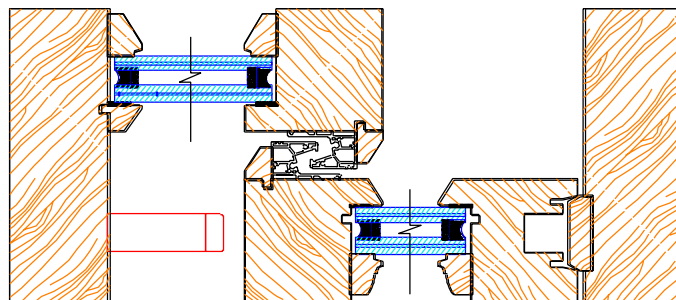

*Part M Cill options to comply with low mobility.

Key Features

- Vacuum cavity glazing combined into a proprietary triple glazed unit, delivering centre pane U-values of 0.4W/m²K. Thinner unit allows for more traditional window dimensions and better aesthetics.
- Locking around the entire perimeter of the frame gives enhanced security performance. Key lockable ironmongery is included with a range of finishes.
- Sophisticated ironmongery allows very large door leafs (up to 3.2m wide) and long runs of up to 19.8m in a 6 door system.
- With the correct building works doors can open and slide into a pocket in the wall, further reducing obstructions.
- Available in double or triple glazing, with the ability to deliver products with U-values of below 1.0W/m²K.
- Panoramic design removes top and bottom rails from side panels to give a more contemporary appearance and better performance.
- Option for removal of side panels and fixing tracking so doors open and slide into a pocket in the wall. Slender 22mm glazing bars and thin profile of the beading reduce the perceived width of the sections. External bar designed to replicate the traditional appearance of putty pointing.

Ongoing Development

The Lift and Slide Doors are continuing to be developed to achieve industry-redefining materials health credentials.

The average number of chemicals used in the average new build home has risen from 50 in 1900 to over 55,000 in a modern home. A classic example of this change can be seen in highly energy-efficient window and door products, where almost all contain a myriad of unnatural, synthesised materials in the form of insulating foams and synthesised coatings. There are reported to be 40,000 deaths each year in the UK due to poor air quality and 2.7% of global diseases are a result of indoor air pollution.

With these startling figures in mind, we set about designing the Frontier Range to be manufactured from natural Accoya timber with no integrated insulation – this required an exceptionally efficient glazing unit to balance the higher conductivity of the frames and we worked with Vacuum Glazing to deliver just that.

We are continuing to work on ventilation and coating systems to further improve the materials' health credentials

What are the advantages over a bi-folding door?

- 1 Large unobstructed vistas.
- 2 Increased surface area of glazing gives superior energy efficiency.
- 3 Doors slide between one another and do not protrude into the outdoor space.
- 4 Can be a more cost effective solution over a long run of doors.
- 5 Flexibility of design.

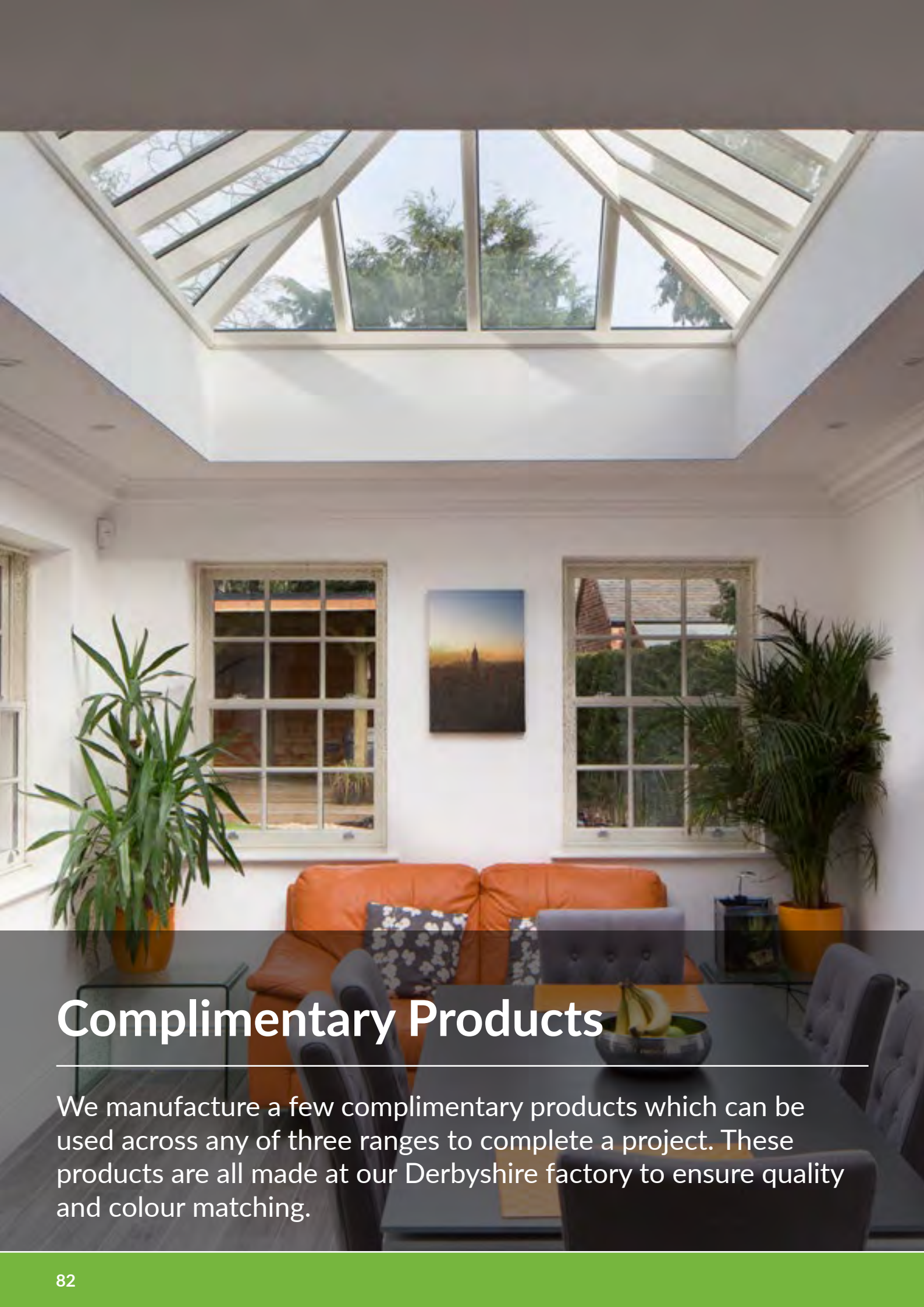

Complimentary Products

We manufacture a few complimentary products which can be used across any of three ranges to complete a project. These products are all made at our Derbyshire factory to ensure quality and colour matching.

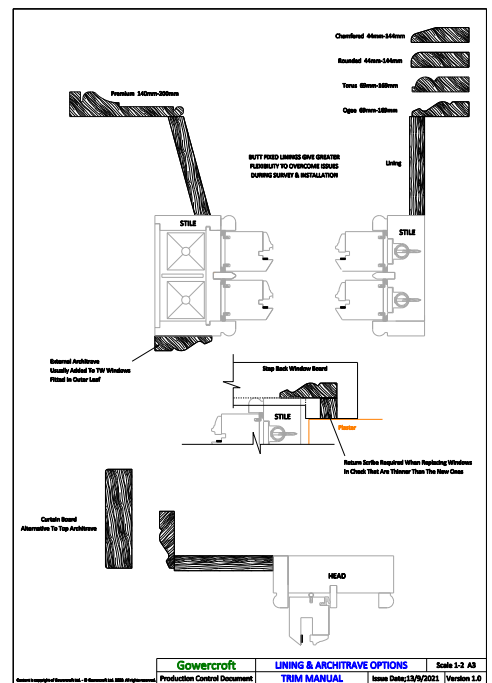
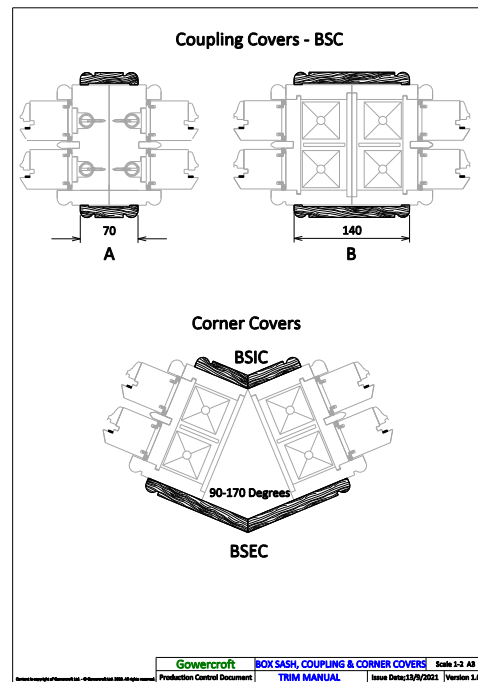

In this section

Roof Lanterns	84
Contemporary Doors	86
Trims & Ancillary Items	88

Additional Products

Roof Lanterns



Dating from the middle ages, roof lanterns are typically incorporated into a larger roof and funnel natural light into the space or room below. With the growing desire of customers to have open and bright living spaces, roof lanterns are becoming increasingly popular within the UK-market.



Gowercroft supply and install roof lanterns throughout the UK on a wide variety of properties.

As standard, we manufacture the lanterns from hardwood, with stepped double glazed units and Aluminium cappings to the outer face of the glazing. This gives a superb balance of appearance, weather-tightness and low maintenance.

We offer (almost) any designs and finishes as you can imagine. We can accommodate Aluminium opening vents controlled manually, by a rocker switch or automatically by a climate control system. We offer a wide range of glazing options to control light, provide self-cleaning or to improve energy efficiency. A popular option is to include a cable management system, which conceals wiring and allows a chandelier or light to hang from the boss.

We can also integrate traditional style aluminium finials to give the lantern an historic flourish. The finials and aluminium cappings can be powder coated in any RAL colour to match the external aesthetic of your property.

During the installation of the product, we coordinate closely with the other trades – providing detailed drawings of preparation required and integrating an internal window-board for the plasterer to work to.

All products are fully factory spray finished with a 10-year guarantee, and are glazed on site to suit the wider schedule.



Additional Products

Hygge Contemporary Doors

Stunning, Cosy Entrance Doors



Hygge is the Danish concept of cosiness and conviviality.

This door range is designed using Continental design concepts and Danish engineered ultra thick door blanks to deliver exceptional performance, sound proofing and comfort. A highly customisable product to suit your exact needs and bring “Hygge” to your home.

This door is available with a full range of magnetic, electronic and regular lever locking systems, which can be operated via fingerprint scanners, mobile apps, or via a simple key. The door design can be heavily customised to vary dimensions, add glazing panels, add bolection moulds or router designs into the face of the panel.



Key Features

- Extreme efficiency, with a door centre pane U-value of $0.7\text{W}/\text{m}^2\text{K}$, utilising a unique 88mm thick door blank.
- Full multi-point locking system on all products with a combination of hooks and deadbolts. These locks deliver good security and help to prevent bow or twist in the door leaf during acclimatisation. Available in magnetic, electronic or regular key operation.
- Ironmongery is included with a range of finishes to suit your property and taste.
- High quality, ball-bearing butt hinges give long life span and excellent functionality.
- Tested to achieve high levels of air tightness and security.
- Available in a variety of designs and in any colour to suit the property.

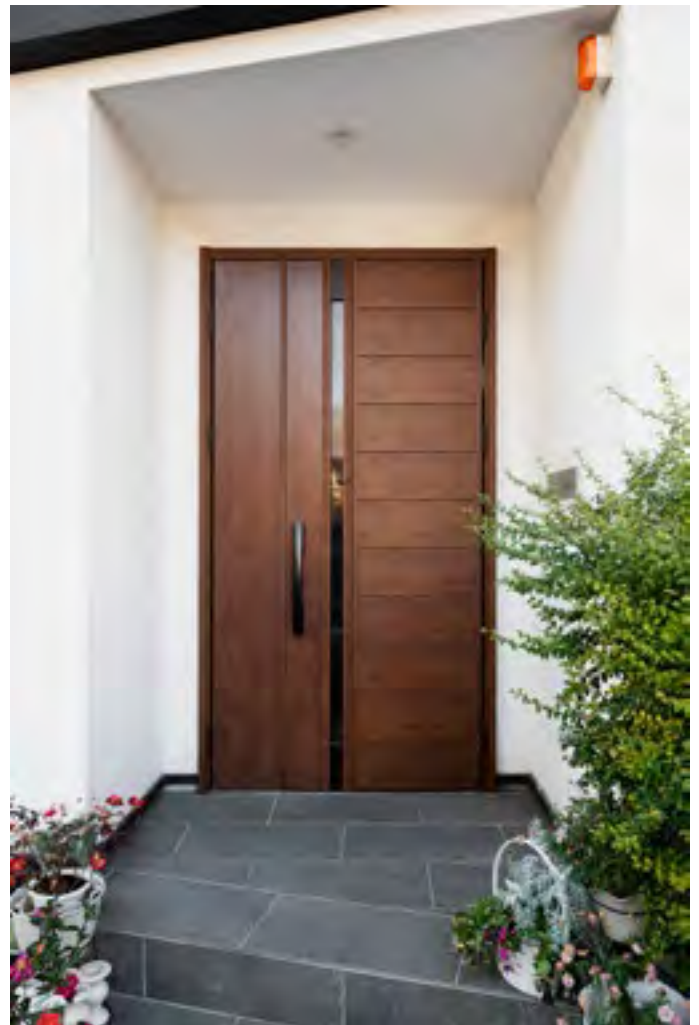

Additional Products

Trims and Ancillary Items

When installing new windows and doors into a property, it is often necessary or preferable to replace the surrounding trims to ensure a neat finish. In other situations an installer might require kite posts, coupling parts or other ancillary parts to complete the installation. It is better to get these from the same supplier to ensure matching colours and mouldings.

Gowercroft offer a full trims manual, which includes hundreds of options to achieve the perfect finish. These range from window boards and architraves, to external linings and quadrants to coupling trims, and bay posts. These are laid out in typical configurations to illustrate how they work and what the final aesthetic will look like. Most of the trims can be flexed or adjusted to suit your individual property. Your sales representative will be able to specify exactly what you need, this page gives a taste of the available options.



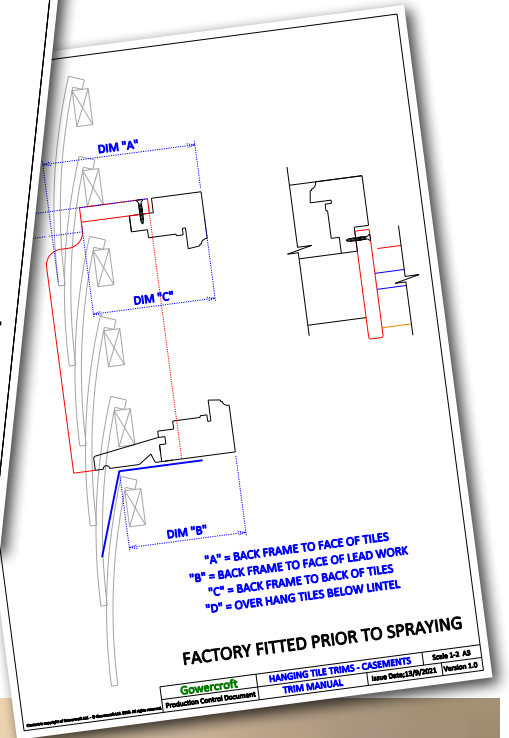
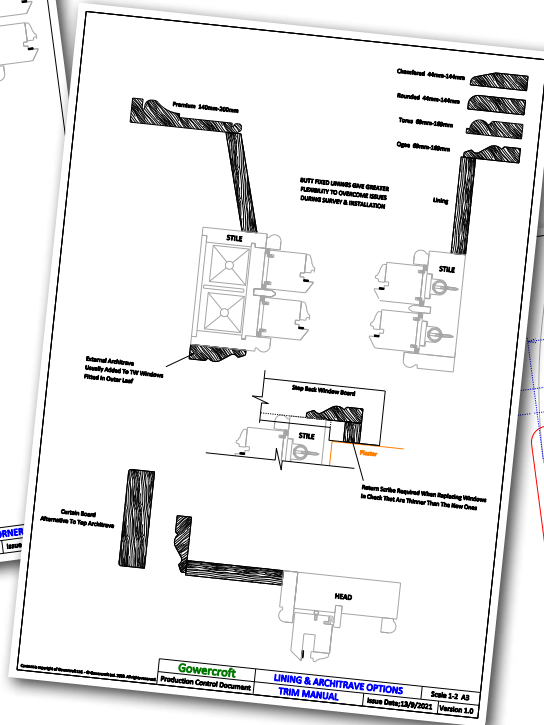
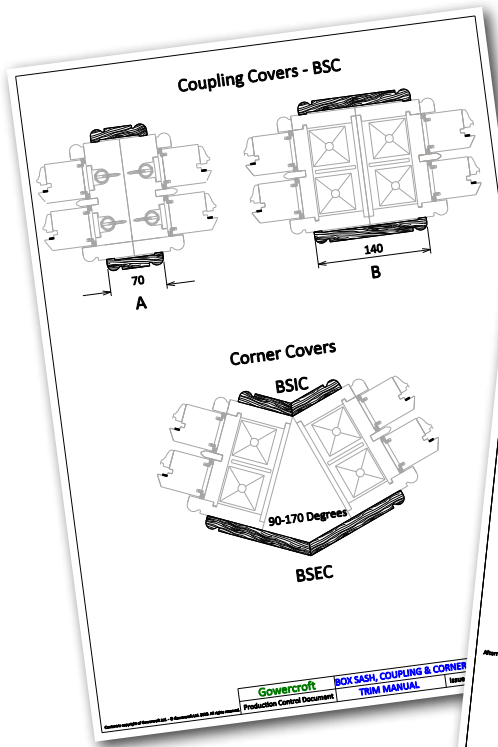



About Gowercraft

We are an award-winning, premium quality, full service, UK manufacturer of external joinery products with industry-leading guarantees. Designing, manufacturing and installing windows, doors, and garden rooms for new build, renovation and heritage projects.



el: 01773 300510
www.gowercroft.co.uk the best



Gowercroft began as a three man operation making security doors in 1998, but have grown over 25 years to become one of the largest timber window manufacturers in the UK. Our products are well known throughout the industry for their beauty, performance and longevity.

In this section

UK Manufacturer	92
Sustainability	94

About Gowercroft UK Manufacturer, Family Owned



We are very proud to be based in the UK and carry out all of our production in our Derbyshire workshop.

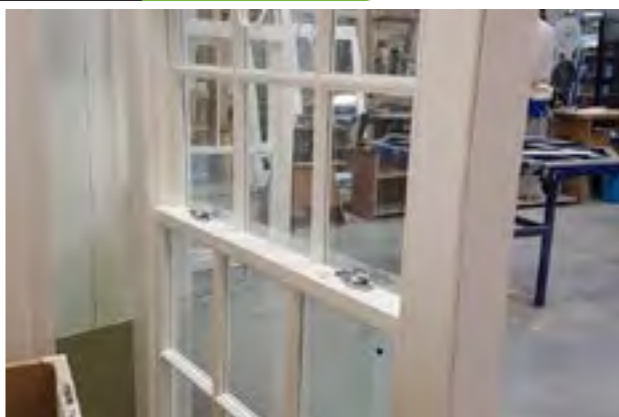

Our workshop as seen through a sash window



Our CNC operator setting up to service a door leaf

We are very proud to be based in the UK and carry out all of our production in our Derbyshire workshop.

We contribute to the UK economy and deliver product based on many years of knowledge of traditional UK joinery design and climatic conditions. We started small in 1998, but we now run a 26,000² ft unit with 70 staff and over £1m in state of the art machinery. This is combined with traditional hand finishing to ensure an exceptional finish.

The most important element of a quality culture is the people involved and each has a responsibility for enforcing standards with the person next to them. For this reason we have always utilised apprenticeships to develop long-term key staff members who understand the requirements. Typically 10% of our total work force is currently in an apprenticeship and many more have graduated and stayed with the business. This has driven us to quality levels unheard of in our industry, with over 99.5% of products arriving on site with no issues reported.

We always welcome existing and potential customers to our workshop. If you are interested in visiting us and seeing our production facilities, simply call your local representative to make an appointment.

 **MADE IN BRITAIN**®



Our technical manager, Gary Chatwood, running through drawing in our workshop

Sashes hanging in our workshop awaiting a second coat



Our leadership team undertaking a quality check on a door leaf before wrapping and dispatch

About Gowercroft

Sustainability

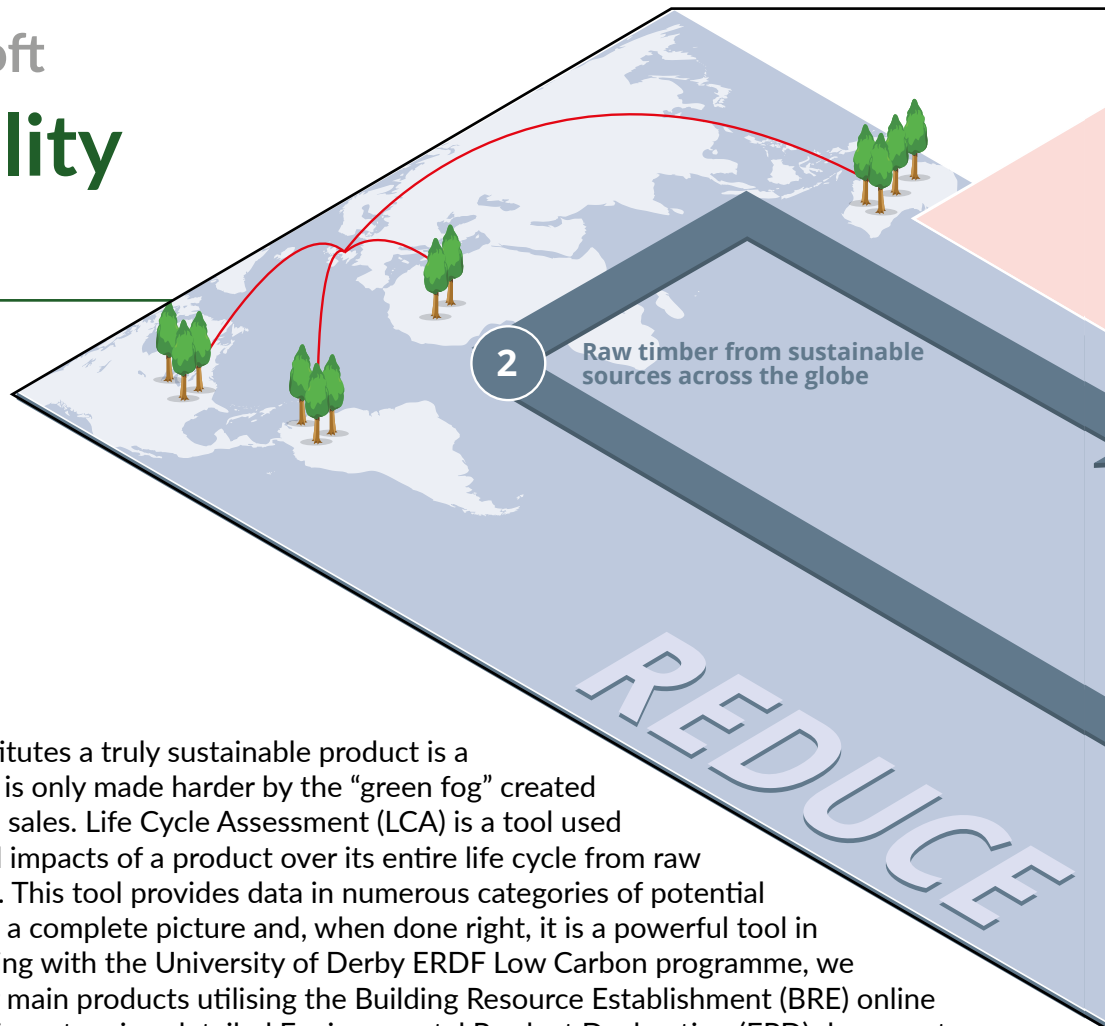

The assessment of what constitutes a truly sustainable product is a complicated area of study and is only made harder by the “green fog” created by unscrupulous firms to drive sales. Life Cycle Assessment (LCA) is a tool used to calculate the environmental impacts of a product over its entire life cycle from raw material to end of life disposal. This tool provides data in numerous categories of potential environmental damage to give a complete picture and, when done right, it is a powerful tool in clearing the “green fog”. Working with the University of Derby ERDF Low Carbon programme, we carried out LCA testing on our main products utilising the Building Resource Establishment (BRE) online LINA tool. The output from this system is a detailed Environmental Product Declaration (EPD) document, which can then be benchmarked against other EPD documents available through BRE’s database.

We carried out an assessment under both the cradle-to-gate and cradle-to-grave categories, which helped us to understand the environmental impact of our products up to completion of manufacture, but also through their entire life cycle.

Cradle to Gate

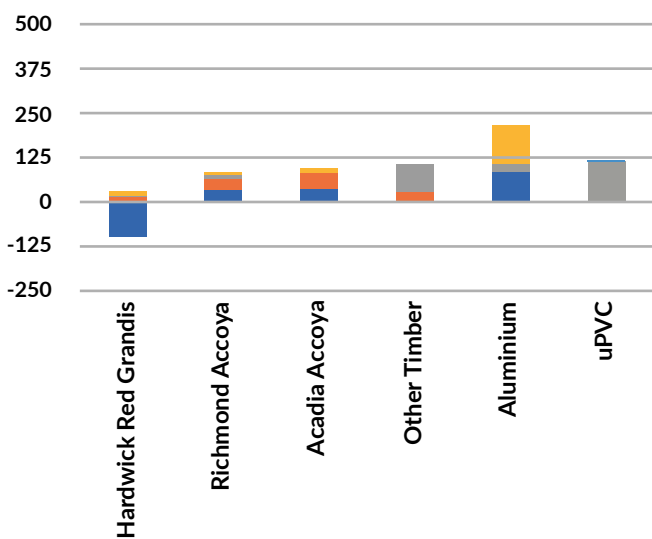

Cradle to Grave

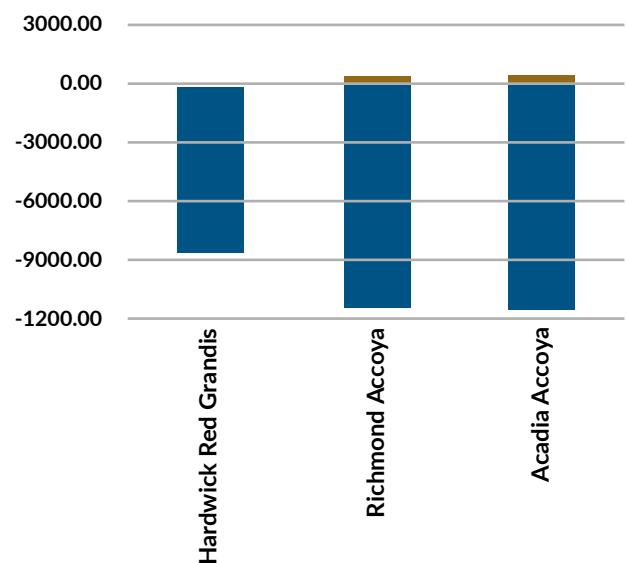

- A1 ■ A2 ■ A3 ■ A4 ■ A5 ■ B1 ■ B2 ■ B3 ■ B4
- B5 ■ B6 ■ B7 ■ C1 ■ C2 ■ C3 ■ C4 ■ D

The breakdown of stages, this helps to demonstrate exactly where in the process the waste or resource is produced/consumed.

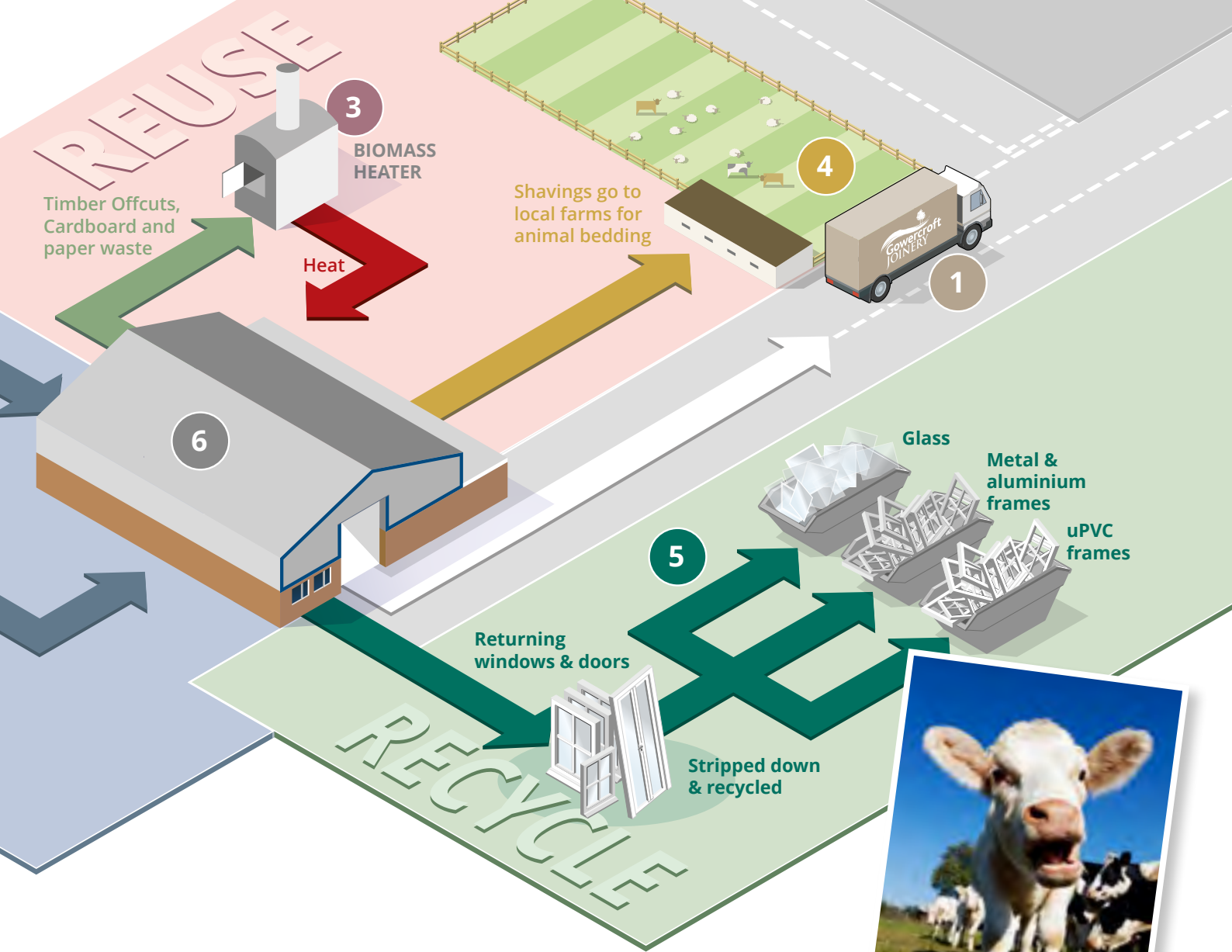

The Hardwick, Richmond and Acadia products have displayed exceptional performance in all categories for Cradle to Grave use and would deliver high levels of life-long sustainability in either a new build or renovation project. While the products also perform better in most categories than the benchmarked alternate suppliers and materials in the Cradle to Gate comparison, it is the longevity of the product offering from Gowercraft and the high level of energy efficiency which stretch that advantage considerably over the Cradle to Grave comparison. To read the full report, please request a copy from your sales representative.

This is the official conclusion from Dr Walker's sustainable windows report:

"All products have some impact on the environment, but materials and manufacturing methods have a significant impact on the level of these emissions. The three Gowercraft window products considered in this comparison have been found to have lower emissions than comparable products manufactured by other timber window manufacturers, and significantly lower emissions than those made from Aluminium and uPVC. This comparison has considered only the raw material and manufacture stages of the products, so a further comparison of the full life cycle emissions of Gowercraft products is recommended to fully understand the life cycle emissions and to consider the emissions reduction of window products when used to replace a low performance older window. End of life treatment is also excluded from this comparison but should be borne in mind, particularly in the uPVC case, considering the relatively short lifetime of this product."



Join us in our effort to reduce paper waste by accessing our brochure on your phone. Simply scan this code using your camera.

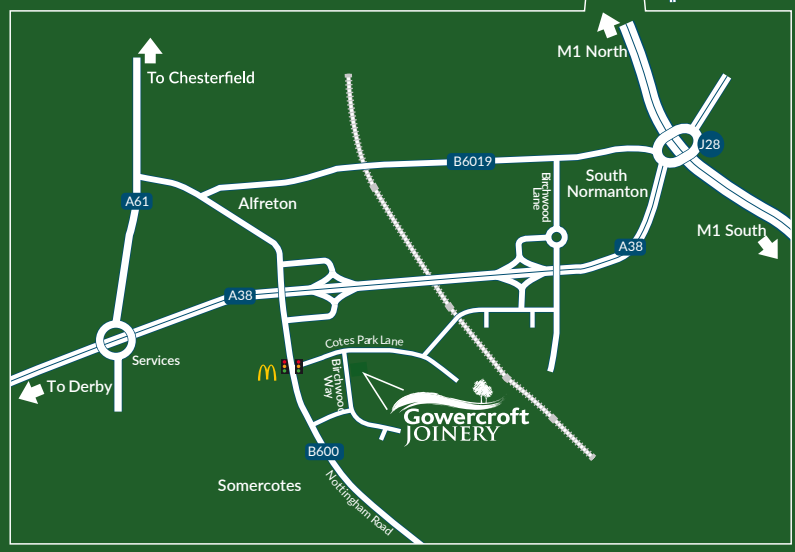
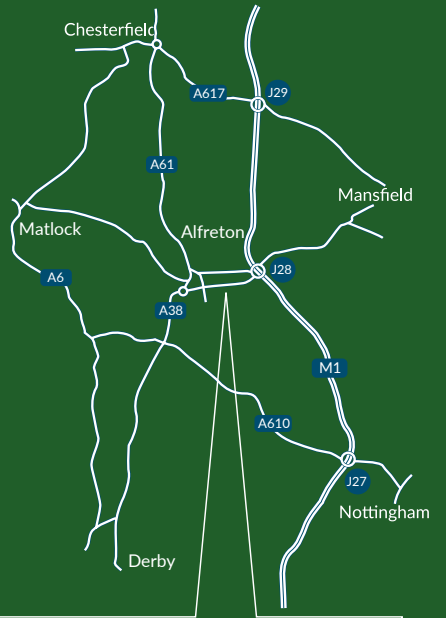

Gowercroft Joinery Limited
Unit 1 Birchwood Way,
Alfreton - Derbyshire
DE55 4QQ

01773 300510
info@gowercroft.com

www.gowercroft.co.uk

